



Northridge Middle School



Morris Berg Architects

FACILITY PROGRAM

MIDDLE SCHOOLS



J.M. Alexander Middle School



FWA Group

04 Jan 2024

LIST OF REVISIONS

Heading	Page	Revision	Rev. Date
1. Team Area	10	Noted to provide a copier alcove, with copier data & power reqts.	11/12/19
2. Gymnasium	28	Added note to locate scoreboard on end wall behind the main goal	11/18/19
3. List of Revisions	1	Added List of Revisions to Facility Program for tracking changes	03/24/20
4. Wellness Room	43	Revised MS Wellness Room to indicate single room configuration	03/24/20
5. Science Classroom	6	Added size of microscopes to be stored in science cabinets	05/12/20
6. Principal's Office	32	Deleted requirement for TV connection and wall bracket	06/29/20
7. Team Area	10	Refrigerator added (to be included in GC contract)	02/10/21
8. Health Room	39	Mini-fridge indicated to be ADA, and included in GC contract	02/10/21
9. Gymnasium	28	Revised bleacher capacity to reference A/E Guide	02/24/21
10. Dance/Theater Arts	21	Note added for Owner to provide current "Perf. Arts Equip. List"	06/25/21
11. Choral/Instr. Music	23	Note added for Owner to provide current "Perf. Arts Equip. List"	06/25/21
12. Student Records	39	Noted to be adjacent to Student Services and Fin. Secretary Offices	11/02/21
13. Reception/Sec's. Area	31	Noted to provide space for 2 work stations behind counter	11/02/21
14. Cafeteria and Kitchen	46	Added electric water cooler with bottle filler in Dining Area	12/03/21
15. Custodial Rooms	50	Shelving added for attic stock materials storage per A/E Guide	12/03/21
16. Choral/Instr. Music	23	Moved location of utility sink to inside Band/Percussion Stor. Room	12/13/21
17. Media Center	25	Deleted Conference Room from Media Center	01/20/22
18. Gymnasium	29	Laundry Room increased to 150 SF, ice maker added	04/21/22
19. Wellness Room	44	Clarified under-counter refrigerator to be by Contractor	06/20/22
20. Modified Restroom	14	Updated grab bar length, lockset indicator, changing table type	07/25/22
21. Makerspace	27	Description expanded and list of Owner-provided equipt. added	05/01/23
22. Gymnasium	29	Revised basketball court from 74'L to 84'L.	08/03/23
23. Dance/Theater Arts	21	Changed reference for fluorescent lights to LED lights	08/11/23
24. Program of Spaces	3	Added Program for MS Athletics/PE Fields	08/23/23
25. Teaching Wall		All references to Teaching Wall state "per detail in A/E Guide"	01/04/24
26. Makerspace	27	Teaching Wall added	01/04/24
27. Markerbds/Tackbds.		Heights of boards clarified between classroom and non-classroom.	01/04/24

TABLE OF CONTENTS

CMS MIDDLE SCHOOL PROGRAM OF SPACES – 54 CLASSROOMS	3
GENERAL CLASSROOM - GRADES 6 TH – 8 TH	4
SCIENCE CLASSROOM AND PREP ROOM.....	6
RESOURCE ROOM	8
TEAM AREA	9
FLEX USE ROOM	10
EXCEPTIONAL CHILDREN’S CLASSROOM	11
MODIFIED RESTROOM	13
HEALTH CLASSROOM	15
CAREER AND TECHNICAL EDUCATION CLASSROOM	16
VISUAL ARTS CLASSROOM	18
DANCE/THEATER ARTS CLASSROOM	20
CHORAL/INSTRUMENTAL MUSIC CLASSROOM.....	22
MEDIA CENTER.....	24
MAKERSPACE	26
GYMNASIUM.....	28
RECEPTION / SECRETARY’S AREA	30
PRINCIPAL’S OFFICE	32
ASSISTANT PRINCIPAL’S OFFICE	33
FINANCIAL SECRETARY OFFICE.....	34
ITINERANT STAFF WORK SPACE	35
CONFERENCE ROOM	36
WORKROOM.....	37
FACULTY BREAKROOM.....	37
STUDENT RECORDS.....	39
HEALTH ROOM	40
STUDENT SERVICES OFFICE & CONF. RM.....	42
PARENT CENTER	43
WELLNESS ROOM.....	44
SRO OFFICE.....	45
CAFETERIA AND KITCHEN	46
PLANT OPERATIONS	49
CUSTODIAL ROOMS	50
STAFF TOILETS.....	51

CMS MIDDLE SCHOOL PROGRAM OF SPACES - 54 CLASSROOMS

8/23/2023

SPACE	QTY	CMS SF	TOTAL SF	SPACE	QTY	CMS SF	TOTAL SF
GENERAL CLASSROOMS				ADMINISTRATION			
CLASSROOMS - 6-8	36	800	28,800	RECEPT. / SECRETARIAL	1	500	500
SCIENCE CLASSROOMS	9	1,000	9,000	PRINCIPAL OFFICE	1	200	200
SUBTOTAL	45		37,800	ASSISTANT PRINCIPAL	3	150	450
SUPPORT SPACES				LARGE CONFERENCE	1	350	350
SCIENCE PREP	3	250	750	SMALL CONFERENCE	1	200	200
RESOURCE ROOM	2	450	900	COUNSELOR OFFICE	3	150	450
TEAM AREA	3	500	1,500	COUNSELOR CONF.	1	250	250
FLEX USE ROOM	1	250	250	WORKROOM	1	500	500
MODIFIED RESTROOM	1	150	150	FACULTY BREAKROOM	1	500	500
WELLNESS ROOM	1	200	200	ITINERANT STAFF OFFICE	1	400	400
SUBTOTAL			3,750	FINANCIAL SECR. OFFICE	1	150	150
ELECTIVE CLASSROOMS				STAFF TOILETS	2	65	130
TECH ED (CTE)	4	900	3,600	HEALTH ROOM	1	250	250
CTE STORAGE	3	200	600	HEALTH ROOM TOILET	1	65	65
VISUAL ARTS CLRM.	1	1,500	1,500	STORAGE	1	250	250
VISUAL ARTS STORAGE	1	250	250	STUDENT RECORDS	1	100	100
KILN ROOM	1	95	95	STUDENT SVCS. OFFICE	1	250	250
DANCE CLASSROOM	1	1,500	1,500	PARENT CENTER	1	250	250
DANCE STORAGE	1	150	150	SRO OFFICE	1	100	100
THEATER ARTS	1	1,800	1,800	SUBTOTAL			5,345
THEATER ARTS STORAGE	1	200	200	CAFETERIA / NUTRITION			
MUSIC / CHORAL CLRM.	1	1,200	1,200	DINING	1	6,100	6,100
MUSIC / CHORAL STOR.	1	200	200	SERVING	1	1,000	1,000
INSTRUMENTAL MUSIC	1	1,500	1,500	KITCHEN	1	3,700	3,700
BAND/PERCUSSION STORAGE	1	200	200	FOOD SERVICE OFFICE	1	125	125
ORCHESTRA STORAGE	1	200	200	LAUNDRY	1	75	75
MUSIC LIBRARY / REPAIR	1	200	200	STAFF TOILET	1	65	65
SUBTOTAL			13,195	STAFF LOCKER	1	75	75
MEDIA CENTER				SUBTOTAL			11,140
MAIN USE ROOM	1	4,200	4,200	BUILDING SUPPORT			
EQUIPMENT STORAGE	1	300	300	MECHANICAL			3,900
MAKERSPACE	1	750	750	ELECTRICAL			1,100
TV STUDIO	1	250	250	GROUP RESTROOMS	10	295	2,950
OFFICE	1	150	150	STAFF TOILETS	6	55	330
WORKROOM	1	200	200	CUSTODIAL			900
SUBTOTAL			5,850	IT (IDF AND MDF)			500
PHYSICAL EDUCATION				SUBTOTAL			9,680
GYM	1	8,500	8,500	BUILDING SUBTOTAL			101,560
GYM P.E. STORAGE	1	700	700	NON ASSIGNABLE			
MULTIPURPOSE STAGE	1	1,500	1,500	CIRCULATION			
BOYS LOCKER	1	1,100	1,100	WALLS			
GIRLS LOCKER	1	1,100	1,100	% OF BUILDING SUBTOTAL	34%		34,530
TEACHER OFFICE	2	150	300	TOTAL SQUARE FOOTAGE			
STAFF SHOWER / TOILET	2	75	150				136,090
PE STORAGE	1	400	400	INDICATES ACTUAL CLASSROOM			
ATHLETICS STORAGE	1	400	400				
TRAINING	1	200	200				
LAUNDRY	1	150	150				
CONCESSIONS	1	300	300				
SUBTOTAL			14,800				

CMS MIDDLE SCHOOL PROGRAM - ATHLETICS

SPACE	QTY
ATHLETICS/PE FIELDS	
PRACTICE / ACTIVITY FIELDS	1
COMPETITION SOFTBALL FIELD WITH BATTING CAGES	1
COMPETITION BASEBALL FIELD WITH BATTING CAGES	1
COMPETITION GRASS FOOTBALL FIELD	1
COMPETITION TRACK	1

GENERAL CLASSROOM - GRADES 6TH – 8TH

OBJECTIVES:

To provide General Curriculum Classrooms at the middle school level intended to function as areas of instruction for mathematics, communication skills, social studies and science. Each space will be designed to accommodate all three disciplines to provide for the greatest amount of flexibility in scheduling and team clustering.

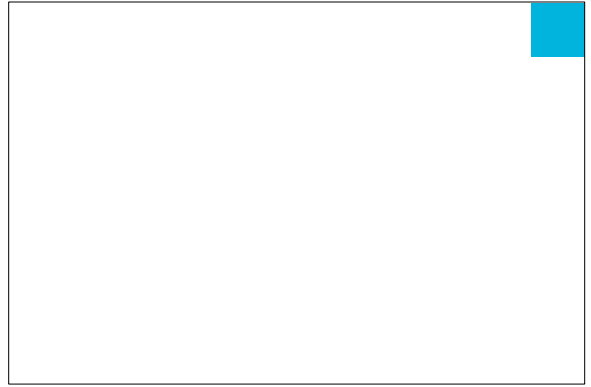

The Mathematics Curriculum should take advantage of the expanding Mathematical capabilities of middle school students to include more complex problem situations involving topics such as probability, statistics, geometry, and rational numbers. Situations and approaches should build on the mathematical language students are acquiring, and help them to develop a variety of problem-solving strategies and approaches. Although concrete and empirical situations remain a focus throughout these grades, a balance should be struck between problems that apply mathematics to the real world and problems that arise from the investigation of mathematical ideas. Finally, the mathematics curriculum should engage students in some problems that demand extended effort to solve. Some might be group projects that require students to use available technology and to engage in cooperative problem solving discussions.

Communication Curriculum is an integrated process that emphasizes the wholeness of language and is most effectively practiced in a language-rich, nurturing environment that focuses on inquiry, interaction, and discovery. Communication involves listening, speaking, reading, viewing, writing, and study skills. It addresses the content of literature and language. Communication is fluid and dynamic. It consists of sending real messages from real speakers. Effective communication requires thinking and responding personally, critically, and creatively.

The Social Studies Curriculum for the middle school grades includes cultural geography courses focusing on Europe, nations of the former Soviet Union, Africa, Asia, and the Pacific Rim. A second emphasis is on the geography, economics, citizenship, and government of the United States with attention to North Carolina. The course emphasizes research of related issues and subsequent communication of research findings. Current events are frequently used as a point of reference for historical issues or a specific topic of inquiry.

CAPACITY:

1 teacher 29 students

ACTIVITIES:

- Actively involving students individually and in groups in exploring, conjecturing, analyzing, and applying mathematics, communications skills, and social studies in a real world context
- Using appropriate technology for computation, exploration, and writing
- Being a facilitator of learning
- Assessing learning as an integral part of instruction
- Conducting independent research for projects
- Presenting individual and small group products
- Using collaborative learning structures
- Creating inter-disciplinary projects
- Conferencing in individual and small group settings
- Integrating curricula to produce uniquely different results for synthesis or evaluation by peers
- Peer tutoring

DESIGN CONSIDERATIONS:

- Core curriculum classrooms should be clustered together with team area, conference room, resource classroom, assistant principal's office and other specialty classrooms of each grade level.
- Provide Teaching Wall per detail in A/E Guide.

PHYSICAL REQUIREMENTS:

Architectural Criteria

- Ceiling height should be 10' minimum
- Each classroom should be free from auditory distraction.
- Acoustic panel ceiling
- Provide 1" mini-blinds to obscure vision during "Lockdown" procedures and/or to darken the room to provide visual clarity for projection systems.
- Doors -Provide 3" wide vision panel in interior door to corridor.
- Floor Finishes - VCT or Rolled rubber, heat welded or VCTT
- Walls - Painted CMU, Painted Gypsum Board, or Painted Pre Cast Concrete
- Provide markerboards and tackboards at Teaching Wall per detail in A/E Guide.
- Provide one 4' x 6' tack board in hallway near the classroom door. Top of tack board to be at 6'-8" AFF.
- 1" mini-blinds for all windows, typical

Mechanical Criteria

- HVAC wall temperature sensor in each classroom

Electrical Criteria

- Provide Teaching Wall per detail in A/E Guide.
- Provide duplex outlets with covers every 6' on center
- Provide switched controls to provide multiple levels of lighting from ceiling fixtures— One switch for inboard lamps at each fixture, a second switch for outboard lamps at each fixture, both located near the classroom entry door off the corridor. Provide a third switch to control the single row of light fixtures nearest the Teaching Wall. Third switch to be located near the Teaching Wall.
- Provide intercom/phone with volume control and privacy feature
- Provide computer network drops and power outlets per A/E Guide appendix
- All outlets for computers on separate circuit

Furniture, Fixtures and Equipment

SCIENCE CLASSROOM AND PREP ROOM

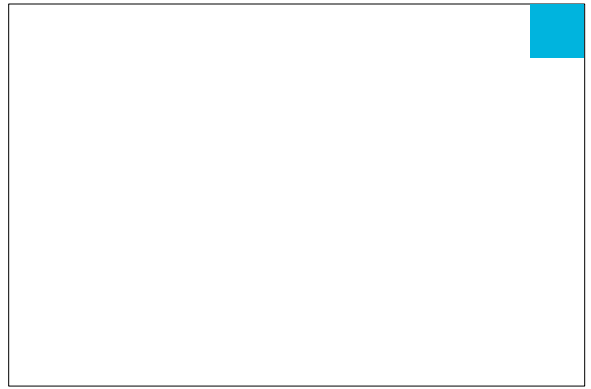

OBJECTIVES

To provide a Science Curriculum for Charlotte-Mecklenburg Schools-based upon the philosophy that science is both process and product. The process results in product knowledge and its application in daily life. The way knowledge is obtained, presented and applied is as crucial as the knowledge itself. The curriculum is founded on five major goal statements: the nature of science; process skills; manipulative skills, attitudes and application; and science concepts.

Middle School is a transitional time for students marked by physical, emotional and social changes. Content is presented from a student-centered perspective placing an emphasis on inquiry, exploration science and based on the North Carolina Standard Course of Study.

In order to produce a more scientifically literate member of society, student experiences must encompass the following objectives:

- Students develop a broad awareness of the nature of science by examining scientific concepts and practicing scientific methods.
- Students acquire process skills through scientific inquiry and by being involved in experiential learning activities.
- Students experience and learn manipulative skills of increasing complexity, accuracy and precision by manipulating various types of equipment, substances and data processing techniques.

CAPACITY

26 students

1 teacher

1 teacher assistant

ACTIVITIES

- Allow students to engage in inquiry, experiential-based activities
- Involve the manipulation of science equipment (e.g., microscopes, balances)
- Show a relevance and application to everyday life
- Involve integration of science, society and technology
- Enhance the student's ability in communication skills
- Foster higher-order and critical thinking skills
- Incorporate a variety of instructional strategies (e.g., cooperative groups, whole class, lecture, discussion, mini-lectures, role-playing, science fair preparation/presentations, independent study)
- Address student learning styles (e.g., auditory, visual, kinesthetic)
- Allow the teacher to become a "facilitator of learning".
- Include the use of technology in learning (e.g., laser video, telecommunications, computer interfacing).

DESIGN CONSIDERATIONS

- Must meet the NCDPI safety guidelines for science classrooms
- Provide Teaching Wall per detail in A/E Guide.

PHYSICAL REQUIREMENTS

Architectural Criteria

- Science labs should be clustered with the core curriculum classrooms of each grade level to accommodate "teaming" of teachers.

- Science labs should be designed to foster a multi-tasking environment ("wet lab", video, multi-media, computer and research areas).
- One prep room shared between two science labs. The prep room should be adjacent to both labs and be accessible through the two labs it serves. It should include exhaust/ventilation system hot and cold running water, lockable storage continuous above and below the counter. A chemical storage cabinet will be located in this space, as well as lockable microscope cabinets. Size of microscopes is base of 16" long x 7" wide, and stand 12" high (confirm with current curriculum).
- Science labs must comply with federal and state safety regulations (e.g., safety equipment, eyewash, fire blanket, fire extinguisher).
- Two student lab tables should be provided. Moveable tables allow maximum flexibility.
- Provide classroom doors with a view panel
- Each science lab will have built-in cabinets with countertop along the wall. Do not use built in table stations.
- Provide base cabinets-along at least two walls for additional work and preparation space. Marker boards and tackable wall surfaces for maps and posters are also needed; allot space for apron storage, eye wash; and plan floor space for a demonstration table and equipment such as laboratory carts, animal or plant study center, and stream table.
- For specialized storage, include a storage cabinet with shelves and drawers of various sizes for science equipment such as skeletons, torsos, and microscopes. Size of microscopes is base of 16" long x 7" wide, and stand 12" high (confirm with current curriculum).
- One teacher demonstration desk (fixed, and offset from Teaching Wall); equipped with water (hot/cold), eyewash, two electrical outlets, one data drop, one upright rod assembly with two support rods
- Work surface material should be resistant to heat, water and chemicals. Stations should contain an assortment of drawers, shelves and 6 sinks per room.
- There should be continuous wall mounted cabinets above the perimeter lab stations.
- Prep rooms should be equipped with hot and cold water, continuous countertops along all available walls with lockable storage above and below the counter.
- 1" mini-blinds for windows.
- Provide markerboards and tackboards at Teaching Wall per detail in A/E Guide. Offset teaching station from Teaching Wall.
- Provide one 4' x 6' tack board in hallway near the classroom door. Top of tack board to be at 6'-8" AFF.

Mechanical Criteria

- A large, deep sink with hot and cold water and 6 linear feet (1.8 meters) of adjacent counter space is needed for various purposes, such as cleaning large containers.
- Exhaust openings must be ventilated away from air intake openings.
- Student's science investigations and cleanup require five or six sinks with water outlets along perimeter countertops or peninsulas. The sinks should be at least 18" (46 centimeters) in each dimension.

Electrical Criteria

- Provide Teaching Wall per detail in A/E Guide.
- Duplex receptacles centralized around group learning areas
- There should be one quadruplex electrical outlet located adjacent to each computer outlet. The computer outlets should be located in a manner to minimize conflicts with other science lab requirements such as HVAC, equipment, etc.

Furniture, Fixtures and Equipment

- Sturdy, movable two-student laboratory tables, at least 54" (137 centimeters) long

RESOURCE ROOM

OBJECTIVES

To provide an additional space for any activity that is conducted with less than a full classroom of students.

CAPACITY

1 teacher

DESIGN CONSIDERATIONS

- Resource rooms should be integrated with grade level classroom areas.
- Provide Teaching Wall per detail in A/E Guide.

PHYSICAL REQUIREMENTS

Architectural Criteria

- Floor: Provide VCT or rolled rubber with heat welded seams
- Ceiling height should be 9' minimum
- Ceiling: Provide acoustical tile
- Windows: Provide sill height 24"-26" AFF with 1" mini-blinds typical
- Doors: Interior doors to corridors are to include a 3" wide vision panel.
- Walls: Provide painted gypsum wallboard, pre-cast concrete or CMU
- Provide markerboards and tackboards at Teaching Wall per detail in A/E Guide
- Provide built-in base cabinets with plastic laminated countertop and stainless steel sink
- Provide wall cabinets with adjustable shelving
- Towel dispenser and liquid soap dispenser to be installed on wall above base cabinet near sink
- Provide one 4' x 6' tack board in hallway near the classroom door. Top of tack board to be at 6'-8" AFF.

Mechanical Criteria

- Provide 24" deep base cabinets with countertop and stainless steel sink in classroom w/hot (tempered) and cold water
- Provide CO monitor in each classroom
- Provide HVAC wall temperature sensor in each classroom

Electrical Criteria

- Provide Teaching Wall per detail in A/E Guide.
- Provide duplex outlets with covers every 6' on center
- Provide intercom/phone with volume control and privacy feature
- Provide computer network drops and power outlets per A/E Guide
- Provide all outlets for computers on separate circuit

Furniture, Fixtures and Equipment

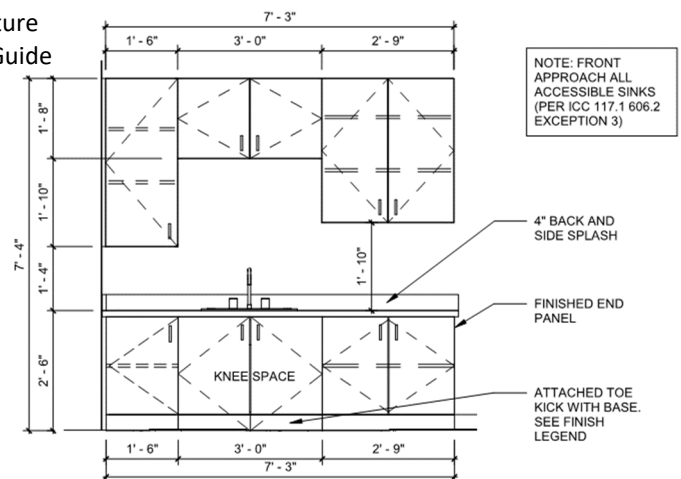
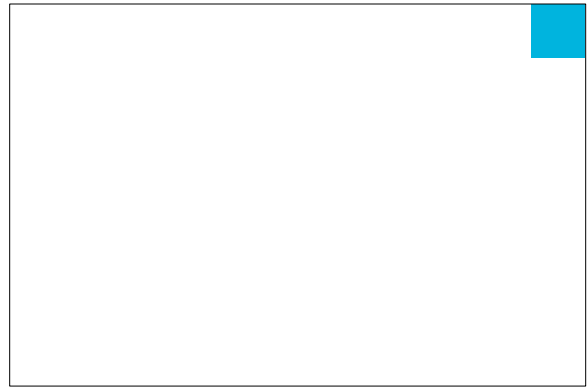

CASEWORK - RESOURCE

1/4" = 1'-0"

TEAM AREA

OBJECTIVES

To provide a private area for the preparation of materials and planning of team issues and for the storage of supplies

CAPACITY

4-16 People

ACTIVITIES

Team teachers engaged in conferencing, scheduling and planning strategies for students and conferences with parents.

DESIGN CONSIDERATIONS

One team area located in close proximity to each grade level classroom wing

PHYSICAL REQUIREMENTS

Architectural Criteria

- Provide a designated area for a copier in the Team Area that is close to the door to be easily accessible from the corridor.
- Provide base and wall cabinets along one wall in the room with a sink. Cabinets to be a combination of closed, open shelf and drawer units.
- Provide 4'x8' markerboard. Top of board to be at 6'-8" AFF.
- Provide 4'x8' tack board. Top of board to be at 6'-8" AFF.
- Provide 1" mini-blinds for windows
- Provide upright residential-size refrigerator (include in GC contract), coordinated with casework.

Electrical Criteria

- Provide network connection for wall-mounted promethean board.
- Provide duplex outlets with covers every 6' on center.
- Provide intercom/phone with volume control and privacy feature.
- Provide computer network drops and power outlets per A/E Guide appendix.
- Provide (2) network drops and power for copier.
- Provide power for refrigerator.

Furniture, Fixtures and Equipment

- Conference Table

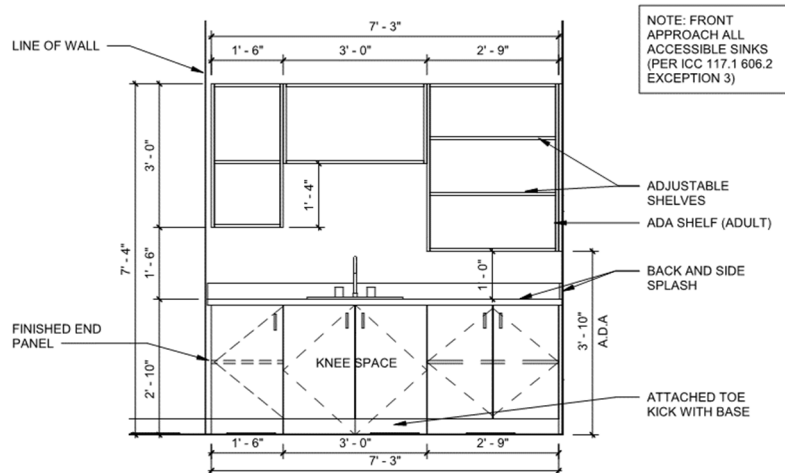
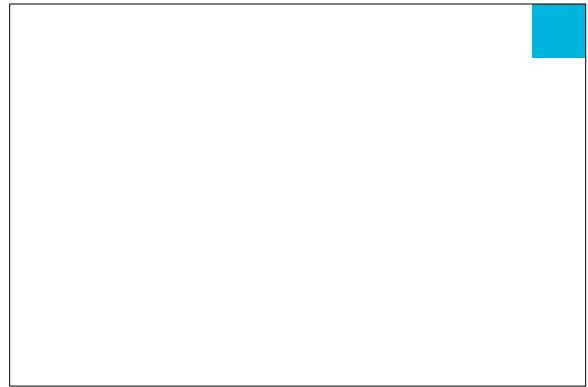

CASEWORK ELEV. - TEAM

1/4" = 1'-0"

FLEX USE ROOM

OBJECTIVES

To provide a smaller flexible teaching space for the whole building. The Flex Use Room will provide classroom extension, itinerant activity space and small group pull-out ability. The actual use of the space will be coordinated among the grade level teachers.

CAPACITY Varies

ACTIVITIES

- Small group instruction, Teaching stations, One-on-one pull out

DESIGN CONSIDERATIONS

- Provide Teaching Wall per detail in A/E Guide.

PHYSICAL REQUIREMENTS

Architctural Criteria

- Floor: Provide VCT or rolled rubber with heat welded seams
- Ceiling height should be 9' minimum
- Ceiling: Provide acoustical tile
- Windows: Provide sill height 24"-26" AFF with 1" mini-blinds typical
- Doors: Interior doors to corridors are to include a 3" wide vision panel.
- Walls: Provide painted gypsum wallboard, pre-cast concrete or CMU
- Provide markerboards and tackboards at Teaching Wall per detail in A/E Guide
- Provide built-in base cabinets with plastic laminated countertop and stainless steel sink
- Provide wall cabinets with adjustable shelving
- Towel dispenser and liquid soap dispenser to be installed on wall above base cabinet near sink

Mechanical Criteria

- Provide CO monitor in each classroom
- Provide HVAC wall temperature sensor in each classroom

Electrical Criteria

- Provide Teaching Wall per detail in A/E Guide.
- Provide computer network drops and power outlets per A/E Guide appendix
- Provide duplex outlets with covers every 6' on center
- Provide intercom/phone with volume control and privacy feature
- Provide computer network drops and power outlets per A/E Guide appendix
- Provide all outlets for computers on separate circuit

Furniture, Fixtures and Equipment

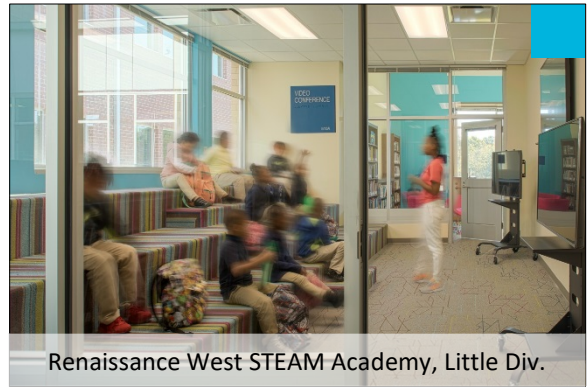

Renaissance West STEAM Academy, Little Div.

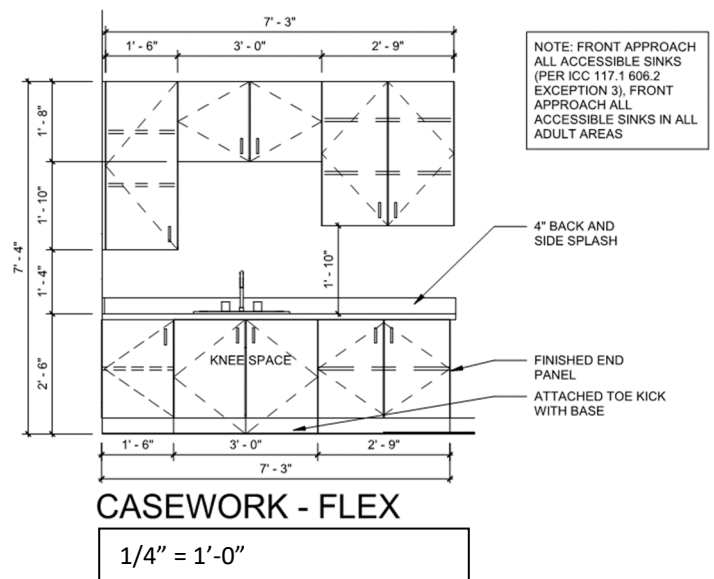

EXCEPTIONAL CHILDREN'S CLASSROOM

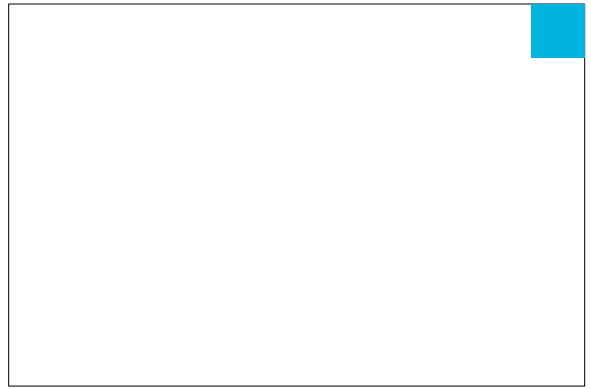

OBJECTIVES

The purpose of Exceptional Children programs is to provide a continuum of services to students with disabilities ages 3-21 so that they may achieve to the maximum extent possible in the least restrictive environment appropriate to meet their needs. To that end, Exceptional Children programming promotes:

- Providing special education services to exceptional children in regular classrooms with non-disabled peers to the maximum extent possible, as appropriate.
- Providing a full continuum of programs and services to help all students achieve to their highest potential.
- Providing related services such as speech therapy and occupational and physical therapy in inclusive learning environments which support the individualized educational program.
- Providing modifications/adaptations to regular education curriculum
- Teaching students using varied learning styles.
- Creating individualized education programs for each identified student.

CAPACITY

1 teacher, 1 assistant, and possibly a physical therapist (The type of EC program will determine the number of students assigned.)

DESIGN CONSIDERATIONS

- Exceptional Children programs should be integrated with the general classrooms.
- Provide Teaching Wall per detail in A/E Guide.

PHYSICAL REQUIREMENTS

Refer to *“Department of Public Instructional Exceptional Children Facilities Planner”* for specific facility design requirements. This document is located in the A&E Guide.

Architectural Criteria

- Locate classrooms on main level, each connected to an adjacent modified restroom, or with modified restroom between two classrooms. If two restrooms provided, prefer to place one restroom with each EC classroom, dispersed into separate areas of building, including second floor.
- Locate classroom near Cafeteria, Media Center, Auditorium.
- Classrooms are to be standard size, 750 square feet. Classrooms are not special in design, and could be used for general population as well.
- Must accommodate students in wheelchairs. Students served could include autism, cerebral palsy, cognitive issues, physical disabilities, muscular dystrophy.
- Provide wireless access point.
- Provide markerboards and tackboards at Teaching Wall per detail in A/E Guide
- Provide vinyl tile floor finish.
- Provide one 4' x 6' tack board in hallway near the classroom door. Top of tack board to be at 6'-8" AFF.

Mechanical Criteria

- Mechanical system needs to be quiet.

Electrical Criteria

- Lighting in classroom will need particular attention to color of light (blue). Consider programmable LEDs for color variation in classrooms.
- Provide cabling in ceiling for classroom camera.
- Provide cabling in ceiling for wireless access point.
- Provide intercom/phone with volume control and privacy feature.
- Provide Teaching Wall per detail in A/E Guide.

MODIFIED RESTROOM

OBJECTIVES

To provide adequate space for toileting and clothes changing area for students needing personal hygiene care under the supervision of a designated adult. The modified restroom is not intended to meet the requirements or fixture counts for ADA accessible restrooms.

CAPACITY

1-3 people

RELATIONSHIPS

- Option 1 (preferred): Located ground level between (2) classrooms and near a main corridor, with corresponding doors to both classroom(s) and to the corridor required.
- Option 2: Located ground level adjacent to (1) classroom, with doors to the classroom and the corridor.
- If two restrooms provided, prefer to place one restroom with each EC classroom, dispersed into separate areas of building, including second floor.

ACTIVITIES

- Toileting, showering, bathing.
- Storage (first aid supplies, linens for beds).
- Teaching life skills.
- Inclusive practices.

PHYSICAL REQUIREMENTS:

Architectural Criteria

- Ceramic tile walls to ceiling, and slip resistant floor tile.
- Wall mounted swing up Grab Bars for toilet, Elementary/K8 30"-32" height, Middle/High 35"-36" height. Length 29 inches at both rails.
- Free rolling toilet paper holder (preferred location on wall mounted swing up grab bars).
- Paper towel and liquid soap dispensers at lavatory.
- Mirror located 1"-2" above sink.
- Soap Dispenser - locate 1"-2" from edge of sink with bottom edge 2" above sink.
- Paper Towel Dispenser – locate opposite soap dispenser 2"-3" from edge of sink with bottom 3"-4" above sink.
- Doors swinging outward to the adjacent classrooms. Door swinging inward from corridor.
- Locks at all doors (thumb turn on bathroom side and key on classroom/hallway side). Accessible lever handles. Locksets to be privacy set with Vacant/Occupied indicator.
- 30"x30" clear floor space to accommodate adaptive toilet seat storage.
- Signage to read "Modified Restroom" (no ADA accessible signage).
- Floor mounted storage cabinet with countertop, shelves and doors, 36" high x 36"-40" wide x 15" deep, with one section lockable for cleaning supplies, and wall cabinet above of matching width, with shelves and doors.
- Space for metal foot-activated trash can, 12 gallon size.
- No curtain required in restroom.

Mechanical Criteria

- Warm/cold water accessible shower w/ hand held shower head.



- Wall mounted sink, tempered/hot water and cold water, standard basin (not elongated) w/ gooseneck faucet with automatic meter for water flow, and 18" clear space both sides, Elementary/K8 29"-31" to rim of sink, Middle/High 34" to rim of sink, 27"-28" to underside of sink basin.
- Scald protection around exposed drainage piping.
- Toilet located center of the wall, Elementary K-1 grades 12"-13" seat height, 2-5 grades 13"-14" seat height, Middle/High 15"-17" seat height.
- Hose bib.
- Adequate ventilation to disperse odors.

Electrical Criteria

- Duplex outlets as required by code.
- Hospital grade electrical outlet 8"-10" AFF and outside the footprint of the changing table to prevent damage to the table and cord during high/low table operation.
- Intercom with volume control and privacy switch located near toilet, and ceiling mounted speaker.

Furniture, Fixtures and Equipment

- Space for Hoyer power lift 44"x42", with electric outlet 8"-10" above floor.
- Space for Changing Table (Performa X-Frame Hi-Lo Changing Table) 72"x25" for Middle/High, 60"x25" for Elementary. Adjustable height table.

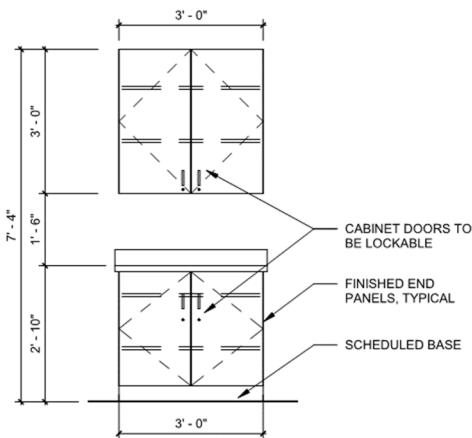

CASEWORK ELEVATION - MODIFIED RESTROOM

1/4" = 1'-0"

HEALTH CLASSROOM

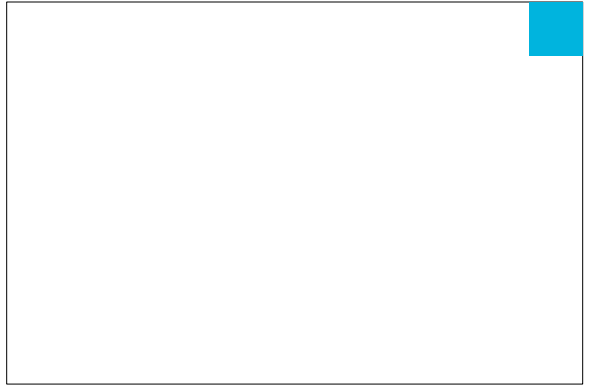

OBJECTIVES

To provide a teaching space to focus on physical health

CAPACITY

26 students 1 teacher 1 teacher assistant

ACTIVITIES

- Teaching students using varied learning styles

DESIGN CONSIDERATIONS

- Health Classroom shall be provided near the school's Gymnasium.

PHYSICAL REQUIREMENTS

- No special facilities are required for Health classroom. It is instructional space and to have all elements, fit and finish of [General Classroom Grades Sixth - Eighth](#).

CAREER AND TECHNICAL EDUCATION CLASSROOM

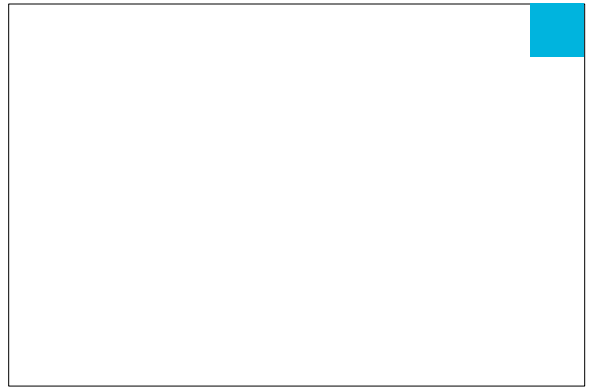

OBJECTIVES

To provide a Career and Technical Education (CTE) program at the middle school level designed to focus on Business Education, Career Decisions, and to introduce students to basic technological principles.

Middle grades courses are designed to develop computer literacy by teaching students basic operation of a computer through the use of software applications. Curriculum competencies include the development of skills in the use of word processing, spreadsheet, database, desktop publishing, and telecommunications software. Additionally, the project-based curriculum is designed to help students explore math, science and technology with a focus on design and problem-solving, team decision making, information gathering, and engineering and technology based careers.

CAPACITY

26 students 1 teacher

ACTIVITIES

Teacher led and project-based learning to include:

- Computer Concepts
- Use of software applications
- Keying data with speed and accuracy
- Multi-media
- Telecommunications
- Information gathering/ analysis of data
- Design/problem solving
- Computer simulations
- Prototype development
- Robotics
- Family and Consumer Science

DESIGN CONSIDERATIONS

- Locate near other CTE course offerings.
- Storage for instructional, and project equipment and supplies
- Provide Teaching Wall per detail in A/E Guide; discuss with CMS Design Manager.

PHYSICAL REQUIREMENTS

Architectural Criteria

- Provide markerboards and tackboards at Teaching Wall per detail in A/E Guide.
- Additional Marker boards as space allows
- VCT or sealed concrete floor.
- Base cabinets with sink and hot/cold water supply
- Lockable cabinet for equipment/supplies storage and overhead shelving
- Teacher console, to include work space for multi-media computer operation
- Overhead mounted AV screen
- Adjustable shelves in all casework

- Access to teacher workroom and office space outside classroom
- Storage room
- Shelves in storage room (18" deep - five shelves floor to ceiling).
- Provide one 4' x 6' tack board in hallway near the classroom door. Top of tack board to be at 6'-8" AFF.

Mechanical Criteria

- Individually controlled HVAC unit sized to accommodate students and equipment

Electrical Criteria

- Thirty-five data drops and associated duplex electrical outlets
- Surge protection for computer circuits
- Electrical outlets around perimeter at floor level and counter-top level
- Indirect glare control lighting - brightness control in addition to more than one light control - light control over projector area
- Dedicated electrical circuit for complete isolation from high load equipment producing power surges
- Provide Teaching Wall per detail in A/E Guide.

Furniture, Fixtures and Equipment

- Student project tables with adjustable height chairs
- Laser printers
- Computer tables with adjustable height chairs
- Printer stands (three)

VISUAL ARTS CLASSROOM

OBJECTIVES

To Provide a Visual Arts classroom for the 21st Century that is reflective of the changing world around us. Students are engaged in learning, both individually and collaboratively how to visually communicate their thoughts with a variety of tools and media. Visual Arts education includes studio production, art history, aesthetics and art criticism. The course of study follows National Art Standards, North Carolina Standard Course of Study and Framework for 21st Century Learning. The environment should lend itself to flexibility, creativity, and problem solving and contain current resources for students.

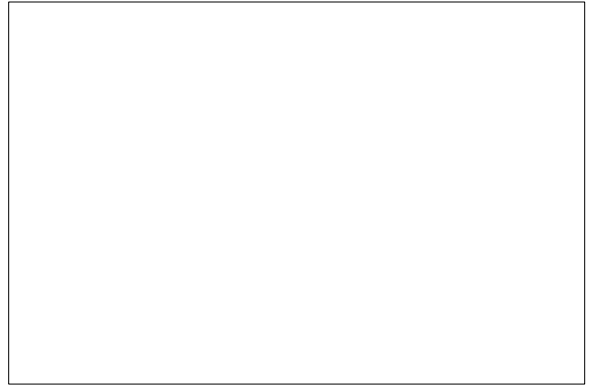

CAPACITY

1 teacher

1 teacher assistant

ACTIVITIES

Students create art using skills developed in:

- Drawing
- Painting
- Printmaking
- Collage
- Textiles
- Ceramics
- Sculpture
- Electronic Media
- Fibers
- Aesthetics

Students study art from around the world, integrating art studies with Social Studies. Resources used include prints, texts, digital images, and internet resources.

DESIGN CONSIDERATIONS

- Students create art in both 2-D and 3-D format. Space is required to create art and space is required for necessary storage.
- Storage for art materials is paramount. Teachers must have ample storage for the wide variety of materials required to complete the Standard Course of Study. There are specific tools for each medium that need to be stored between each year's use.
- In addition to student work space, countertops, and storage, there must be floor space provided for the standard visual arts equipment. See attached list.
- Visual resources, including prints, textbooks, digital images and websites are frequently used by the teacher and must be accessible for up-to-date instruction in visual arts. Storage for these items must also be available in the classroom.
- Visual Arts Education is available to all students in the school, which includes any exceptional students.
- Relation to entries: Location on the first floor at the end of a corridor is ideal for easy exit and noise isolation. An exit door located from the art room onto an exterior patio will be utilized if provided.
- Provide kiln room accessible from classroom.
- Provide Teaching Wall per detail in A/E Guide

PHYSICAL REQUIREMENTS

Architectural Criteria

- Floor: Provide sealed concrete floor
- Ceiling height should be 10' minimum
- Ceiling: Provide acoustical tile
- Windows: Provide sill height 24"-26" AFF with 1" mini-blinds typical
- Doors: Interior doors to corridors are to include a 3" wide vision panel.
- Walls: Provide painted gypsum wallboard, pre-cast concrete or CMU
- Provide markerboards and tackboards at Teaching Wall per detail in A/E Guide
- Provide built-in base cabinets with plastic laminated countertop and stainless steel sink
- Provide teacher coat closet w/lock 36" wide x 24" deep x 88" high
- Provide wall cabinets with adjustable shelving
- Towel dispenser and liquid soap dispenser to be installed on wall above base cabinet near sink
- Provide forty 3" deep portfolio drawers
- Provide shelving for 180 textbooks in the ES Visual Arts room
- Provide 36" deep base cabinet with minimum 36" clear above for paper cutter located away from sink
- Provide as much 24" deep shelving as possible in storage room
- Provide space for two 2'x3' carts in the kiln room
- Provide two 4'x8' marker boards. Top of board to be at 6'-8" AFF.
- Provide lockable display cases in corridor/public areas
- Provide 8' tack board. Top of board to be at 6'-8" AFF.
- Provide open adjustable shelving above all base cabinets.
- Provide one lockable storage cabinet 42"W x 84"H x 26"D with plastic storage bin storage
- Provide one 4' x 6' tack board in hallway near the classroom door. Top of tack board to be at 6'-8" AFF.
- Provide 1 kiln

Mechanical Criteria

- Provide stainless steel scullery sink 18-22" with sidebar and plaster trap
- Provide 1-2 stainless steel hand wash sinks with plaster traps
- Provide hot and cold water to all sinks
- Size ventilation in Kiln Room to discharge excessive heat created by the kiln

Electrical Criteria

- Provide Teaching Wall per detail in A/E Guide.
- Provide additional duplex outlets minimum of two per wall – coordinate mounting height casework
- Provide ability to dim lights
- Provide intercom/phone with volume control and privacy feature
- Provide computer network drops and power outlets per A/E Guide appendix
- Provide all outlets for computers on separate circuit

Furniture, Fixtures and Equipment

DANCE/THEATER ARTS CLASSROOM

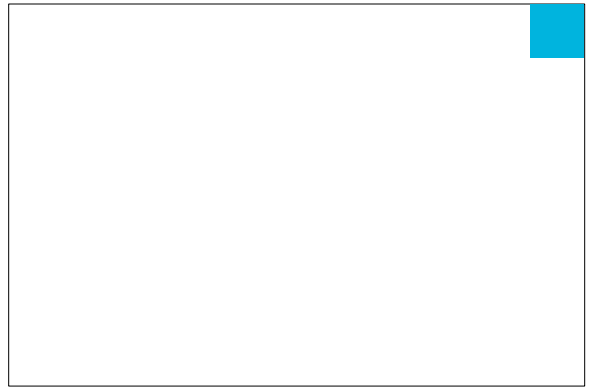

OBJECTIVES

Dance

To provide a classroom where students who are engaged in middle school dance learn to communicate through movement, both individually and collaboratively. The course of study follows national Dance Standards, North Carolina Standard Course of Study, and Framework for 21st Century Learning. Dance Education is based on principals of modern and ballet dance. Emphasis is on developing technical, choreographic, and performance competencies. A flexible environment that lends itself to creativity and problem solving through movement is necessary for successful dance instruction. Because of the physical nature of this course, the classroom must provide for the SAFE, physical development of the students.

Theater Arts

To provide a Middle School Theatre Arts program where students begin to develop theatre literacy. Through active creation of theatre, students learn to understand artistic choices and to critique dramatic works. They play a larger role in the planning and evaluation of their work. Middle school students use drama as a means of confidently expressing themselves. With greater emphasis on reading, writing, and performing scripts, students begin to create plays based on peer issues, concerns and interests using improvisation and collaboration. Students are introduced to plays and experiences that reach beyond their communities to national, international, and historically representative themes. Curriculum objectives for the middle school Theatre Arts Program are found in the North Carolina Standard Course of Study.

CAPACITY

40 students 1 teacher

ACTIVITIES

Dance

Moving

- Large and small groups in place for floor work
- Small group choreography
- Performance rehearsals
- Informal performances

Listening

Viewing

- Recordings
- Guest artists
- Dance groups

Lecture and demonstration

Theater Arts

- Students working in both large and small groups as well as on individual assignments
- Students participate in speaking, moving, creating, and evaluating. They demonstrate basic speech concepts and acting skills.
- Students planning and presenting dramatic situations and learning basic technical theater skills
- Creating and producing original scripts as well as acting and producing dramatic productions.

DESIGN CONSIDERATIONS

- Room should be near locker room for changing purposes
- Optimal location is near theater class in arts wing
- Should not be near media center or classrooms due to noise level
- Classroom should have easy access to the Multipurpose Room Platform
- Proper acoustical treatment and location in the building should allow for the activities of the theatre arts class involving sound.
- Acoustical treatment should provide a reverberation time of no more than 1.0 seconds.
- Lockable storage for Dance Classroom
- A secure lockable storage area is required for audio-visual equipment, set storage, costume storage, and incidental theater items.
- Provide Teaching Wall per detail in A/E Guide

PHYSICAL REQUIREMENTS

Architectural Criteria

- Floor should be either, semi-permanent sprung wood floor with Marley covering or Harlequin dance floor with cushioning and appropriate finish.
- Acoustical properties to prevent disturbing other classes and echoing of music in room.
- Absorber and diffuser panels should be utilized to provide appropriate acoustical properties and a quiet environment.
- Walls should be clear of fixed furniture and casework.
- Shatterproof mirrors should be mounted on at least one wall - Mirrors should be 6 feet in height, 2 inches from the floor, and should extend at least 24 feet long.
- Two Dance Barres installed at 36" and at 42" AFF on the wall opposite the wall with the mirror.
- One bulletin board.
- Lockable Storage Room. Owner to provide current "Performing Arts Equipment List" for use in planning for storage needs of loose music equipment and instruments.
- Rack for storing hanging costumes in Storage Room.
- Shelving for storing boxed costumes, props, and instruments in Storage Room.
- Bookcase for storage of textbooks in Storage Room.
- Storage for technology equipment (cameras, lighting, etc).
- Storage for miscellaneous resources.
- Water fountains should be easily accessible.
- Exterior windows should have 1" mini-blinds.
- Provide markerboards and tackboards at Teaching Wall per detail in A/E Guide
- Located near dressing rooms.
- Provide one 4' x 6' tack board in hallway near the classroom door. Top of tack board to be at 6'-8" AFF.

Mechanical Criteria

- Individual heat and air conditioning control.
- Physical nature of dance activities and age of students should be considered when calculating the fresh air ventilation rate.
- Quiet air handling system should be specified.
- Fan control to ventilate odors from the room.

Electrical Criteria

- LED lights recessed in the ceiling throughout the room.
- Ability to dim lights.
- Provide Teaching Wall per detail in A/E Guide

Furniture, Fixtures and Equipment

- A portable 300 square foot stage platform (recommend Wenger staging), 24 inches in height, located at one end of the room to provide a space for rehearsals and small group performance.

CHORAL/INSTRUMENTAL MUSIC CLASSROOM

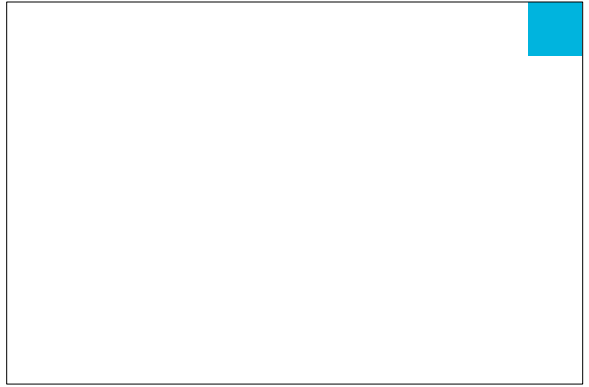

OBJECTIVES

Choral

To provide a middle grades choral music program designed as a bridge between elementary and high school music programs. Singing experiences are adjusted to accommodate the changing voice. Presentation of work is a natural progression in the study of music. Students are provided opportunities for performances and informances, which demonstrate the process of how students arrive at a performance. Based on the objectives found in the North Carolina Standard Course of Study, students learn to define the roles of performers and audience members.

Instrumental Music

To provide an instrumental music program in the middle grades designed as a bridge between elementary and high school music programs. Students have the opportunity to study band, orchestra, or jazz band. Presentation of work is a natural progression in the study of music. Students are provided opportunities for performances and informances, which demonstrate the process of how students arrive at a performance. Based on the objectives found in the North Carolina Standard Course of Study, students learn to define the roles of performers and audience members.

CAPACITY

1 teacher

ACTIVITIES

- The primary activity is the study of performance techniques and music literature through large group instruction.
- Small ensemble and individual or small group instruction are frequent parts of the instructional plan.
- Opportunities are provided for independent learning and the development of basic music knowledge and skills related to the literature studied.

DESIGN CONSIDERATIONS

- The choral music program works jointly with dance and drama
- Easy access to the platform as well as to other performing arts classes is important.
- Consideration should be given to the location of music rooms to aid in acoustical design toward isolating sounds from quieter learning environments
- Provide Teaching Wall per detail in A/E Guide

PHYSICAL REQUIREMENTS

Architectural Criteria

- Provide ceiling height of 16-20 feet
- Provide acoustical reverberation time of up to 1.3 seconds. The facility should be treated with absorber and diffuser panels to provide appropriate acoustical properties and a quiet environment
- Provide 4' wide door to allow movement of large equipment, solid - no vents in doors.
- Walls should acoustically treated and the room should have a sound transmission classification of at least STC 50 for both interior and exterior walls and STC 45 for doors and windows.
- The floor should be flat. Provide VCT floor finish in the classrooms and in storage areas
- Provide drinking fountain within the classroom or nearby
- Provide markerboards and tackboards at Teaching Wall per detail in A/E Guide

- Provide one white dry-erase board with permanent music staff lines (Wenger #172B111, 4 ft. x 8 ft.) located at Teaching Wall.
- Provide lockable Storage Room for music library, six portable choral risers, keyboard, stereo equipment, props and shelving for choral music books, sheet music etc. Owner to provide current “Performing Arts Equipment List” for use in planning for storage needs of loose music equipment and instruments.
- Provide casework in classrooms to accommodate textbooks, resource books, recordings, CD’s, CD player and speakers
- Provide lockable Storage Rooms for Band and Orchestra
- Provide one 4’ x 6’ tack board in hallway near the classroom door. Top of tack board to be at 6’-8” AFF.

Mechanical Criteria

- A quiet air-handling system should be included. Temperature control should be zoned, with temperatures being maintained within a 2-4 degree range and humidity between 50-60 percent. The area should be well ventilated, but air flow should not produce drafts.
- Locate drinking fountain near classroom
- Provide deep utility sink with gooseneck faucet or flexible sprayer located in the Band/Percussion Storage Room for cleaning instruments

Electrical Criteria

- Provide Teaching Wall per detail in A/E Guide.
- Provide lighting of 70-100 foot candles throughout.
- Provision should be made for darkening the room for use of audiovisuals
- Additional duplex outlets minimum of one per wall – coordinate mounting height with risers
- Provide intercom/phone with volume control and privacy feature
- Provide computer network drops and power outlets per A/E Guide appendix
- Provide all outlets for computers on separate circuit

Furniture, Fixtures and Equipment

- Provide space for upright piano
- Provide risers – 42”L x 24”H x 20”W

MEDIA CENTER

OBJECTIVES

To provide a dynamic and essential physical and virtual space for personalized learning, knowledge construction, and academic achievement through the 21st century media center. To provide an information and knowledge space where students develop the necessary information and technology literacy skills to enable them to innovate and create new knowledge. The media center stimulates collaboration, communication, critical thinking, questioning and creativity through project-based authentic learning opportunities.



The resources must be current, multi-perspective, multi-formatted, and aligned with the American Association of School Librarians *Standards for the 21st Century Learner*, North Carolina Department of Public Instruction academic content standards, Charlotte-Mecklenburg Schools Strategic Goals 2018, and guidelines from Virtual Learning and Media Services.

The infrastructure in all areas of the media center should provide “state of the art” technology infrastructure for students to inquire, think critically, draw informed conclusions, and apply knowledge to new situations. The tools needed to organize, share, and produce this knowledge in a safe online environment community should be readily accessible to everyone in the school learning community.

CAPACITY

4-6 sq. ft. per student

ACTIVITIES

MAIN-USE ROOM- Must allow visibility from the circulation desk to all areas within the main room; e.g., primary storytelling area, instructional class spaces, individual and small group collaborative spaces, leisure reading and entry doors to the room.

- **Storytelling Area** (ES) should include elements that stimulate and encourage the learning process for early learners. It should be located away from the heavy traffic flow and near the low shelving specifically designed for easy/picture books. This area should be flexible to provide space for different purposes and groupings. A presentation system and story rug should be furnished for this area
- **Instructional Space** is needed for small and large groups (up to two classes simultaneously) since a major emphasis of the media center is instruction. A presentation system and age appropriate tables and chairs should be furnished for this area
- **Circulation** should be located adjacent to entry doors from the main corridor with visual control and access to workroom, TV Studio, and offices.
- **Leisure Reading Area** should accommodate lounge furniture to support collaboration and group work
- **Technology** to be wireless with ample power sources throughout the space. Provide space and infrastructure for two charging carts
- **Workroom** should be near the circulation desk; this room accommodates shelving for resources, tables and perimeter cabinets for equipment (laminator, poster maker, etc) and tables and chairs for group collaboration.

- **Storage Room** should have direct access to the main use room and should be equipped with 18 and 24-inch deep shelving, used primarily for equipment storage. Provide ample power sources for the charging of laptops carts
- **Television Studio** should be in close proximity to the Circulation Desk/Workroom/Office. No windows. It should be equipped for school wide broadcasting on a daily basis. Consideration should be given to the shape of the studio for broadcast desk, camera locations and lighting configurations with a green wall behind the location of the anchor desk.
- **Office** should be adjacent to circulation and have a window to allow for visual control of the main use area while sitting at the office desk. The office should be generous in space to allow the media specialist to work with staff, collaborate with teachers, and vendors, design lessons, and have conferences.

DESIGN CONSIDERATIONS

The Media Center should be located centrally on the ground floor for easy access from all learning areas, and away from noisy areas such as the cafeteria or multi-purpose room. There should be distinct internal “rooms” and no blind spots. The Media Center should be designed for multiple functions both during school hours and after. It would ideally have an exit onto a patio and be convenient to group restrooms for evening use by the public.

PHYSICAL REQUIREMENTS

Carpet, data outlets, phone/intercom, two instructional presentation spaces (primary storytelling and one large group instructional area

- Provide circulation desk with wide view of main floor and quick access to phone and main entrance with generous adjustable shelving behind desk. Desk to include lockable pencil drawers, lower cabinet drawers, counter top space for a printer, purposefully designed space for computers/book scanners, student self check out and a depressible mobile book drop with slit opening in the circulation desk.
- Provide simple square or rectangular room shape with no columns
- Placement of network jacks and sources of power is crucial in overall layout and flexibility of space.
- Careful placement of windows to complement bookshelf locations and heights
- Defined instructional areas wired for two Teaching Walls per detail in A/E Guide. Lighting to be independently switched for clarity of projections and darkening of different parts of the room
- Design to be sensitive to shapes and sound transmissions to avoid acoustical problems
- Floor boxes with data, and electric connections
- Intercom/Phone with adjustable volume

MAKERSPACE

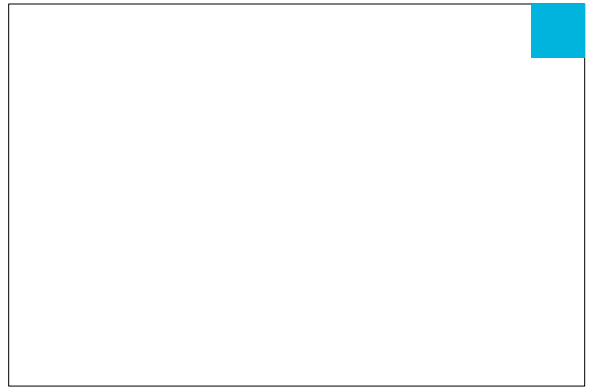

OBJECTIVES

Provide flexible space for hands on learning, digital learning, CTE.

ACTIVITIES

Team teachers engaged in conferencing, scheduling and planning strategies for students and conferences with parents.

DESIGN CONSIDERATIONS

To be located adjacent to the third Large Group Instruction area of media center. Provide windows for observation by staff and other students. Provide Teaching Wall per detail in A/E Guide; discuss with CMS Design Manager.

PHYSICAL REQUIREMENTS

Architectural Criteria

- Provide base and wall cabinets along one wall with a sink, per Casework Elevation below, with the following:
 - Closed cabinetry with lockable storage with electrical capacity to securely store devices while charging (iPads, small robots, etc.) and for storing devices we don't want students to access such as tools.
 - Open casework for some books and display of student work.
 - Counter for placing 3D printer and/or other equipment listed in chart below.
- Maximize the number of marker boards available in the space.
- Provide two 4'x4' tack boards. Top of board to be at 6'-8" AFF.
- Provide markerboards and tackboards at Teaching Wall per detail in A/E Guide.
- Provide 1" mini-blinds for windows

Mechanical Criteria

- Provide individually controlled HVAC unit sized to accommodate students and equipment.
- Provide hot and cold running water to sink.

Electrical Criteria

- Provide sixteen network drops with a minimum of two network drops available above base cabinets.
- Provide cabling in ceiling for classroom camera.
- Provide cabling in ceiling for wireless access point.
- Provide duplex outlets elsewhere around the space at 6' on center.
- Provide three electrical power reels mounted to the ceiling space evenly through the space.
- Provide intercom/phone with volume control and privacy feature.
- Provide Teaching Wall per detail in A/E Guide.





Furniture, Fixtures and Equipment

- Five tables with seating for 30 students. The size and height of tables is determined by the dimensions of the space and the grade level. Elementary is usually tables and chairs and secondary is counter height table with stools.
- 1 teacher chair (casters) and a mobile pneumatic teaching station
- 2 storage carts on casters with removable bins/trays
- 1 mobile dry erase or glass board

Materials and Supplies by Owner

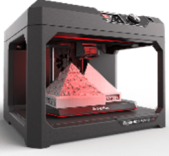
- | | | |
|----------------------------------|----------------------------|------------------------------|
| ○ Toolkit and box cutter | ○ Arduino starter kit | ○ Wonder Workshop Dash robot |
| ○ Snap and squishy circuits | ○ Buddha Board | ○ <i>Strawbees</i> |
| ○ K'Nex, Legos, Magformers, etc. | ○ 3Doodler 3D pen set | |
| ○ Keva planks | ○ Makey Makey Kit | |
| ○ Cardboard construction kits | ○ Ozobots or Sphero robots | |

Makerspace Equipment

Device	Link to Device	Specifications	Image
Makerbot Replicator 3D printer (provisioned by Technology) Needs dedicated laptop or desktop and electrical access	Makerbot Replicator	52.8 L X 44.1 W X 41.0 H CM [20.8 X 17.4 X 16.2 IN]	
Poster Maker (requires electrical outlet and possibly network drop) Provisioned by school	Presentation Systems South Learn on Demand Poster Maker System	Height 38" Width 41" Depth 41"	
Cold Laminator (does not require electrical outlet - hand crank) Provisioned by school	Presentation Systems South Cool Lam	Height 18" Width 28" Depth 28"	
Roll Laminator (requires electrical outlet) Provisioned by school	Laminex lamintor PDF User Guide	Height 15" (381 mm) Width 34" Depth (with feed tray) 20" Net Weight 66 lbs.	
Cricut Maker 3 Machine Needs electrical access	Cricut Shop	26.25 x 11 x 11.2 inches	

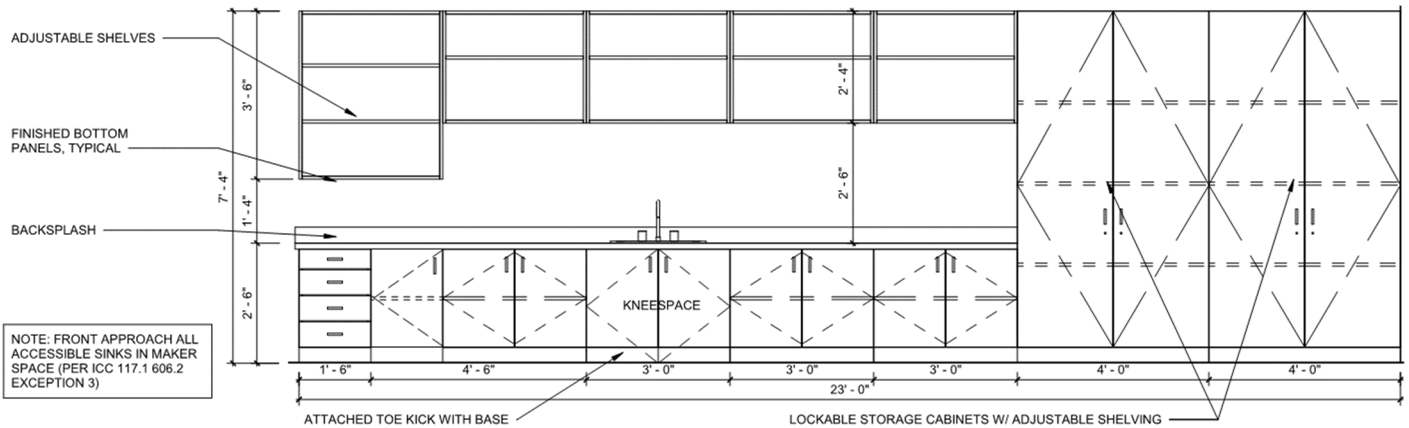

CASEWORK ELEVATION - MAKER SPACE

1/4" = 1'-0"

GYMNASIUM

OBJECTIVES

To provide positive attitudes and behaviors for a lifetime commitment to joyful physical activity and good health. Physical Education is a sequential instructional program that provides learning experiences that develop physical and mental fitness, motor skills, and moral social behavior. It is based on the study of human movement and includes educational games/sports, dance, and gymnastics with fitness concepts integrated into all of the content areas. A variety of teaching styles is used to develop experiences that encourage students to become efficient, versatile, and creative movers.

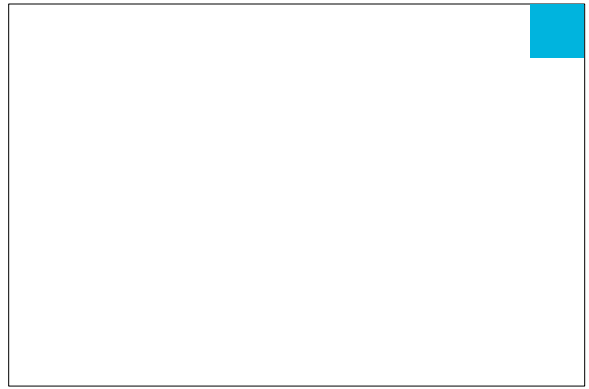

CAPACITY

170 students 2 teachers

ACTIVITIES

- Development of team sport skills, small group, and individual activities both indoors and outdoors.
- Individual and dual sports (golf, tennis, gymnastics/tumbling and apparatus work, badminton, and ping pong)
- Creative dance (square, line, social, and aerobics)..
- School Assemblies.

DESIGN CONSIDERATIONS

- Gym should open onto exterior playing field with covered entrance and accessible concrete sidewalks.
- Group toilets and drinking fountains in the hall near the gym and near the playing field for community use.
- A custodian room should be located close to the gymnasium.
- Students should not have to cross parking lots or streets to get to the field from the locker rooms or gymnasium.
- P.E. offices should be located near the locker rooms for audible and visual connections to all occupied spaces.
- Storage room with electrical outlets.
- Locate the Health Classroom adjacent to the Gymnasium.
- Laundry Room to have residential washer and dryer, and smaller size ice maker.

PHYSICAL REQUIREMENTS

Architectural Criteria

- Wood floor.
- Striping for Competition Basketball 84'x50'.
- Striping for Competition Volley Ball 60'x30' with in-floor sleeves for net stanchions.
- Striping for two P.E. Volley Ball Courts (perpendicular to competition court, side-out lines to be out of basketball rim plane of influence).
- Striping for four half courts for basketball (perpendicular to competition court).
- Accessible bleacher seating capacity per A/E Guide, with enclosed ends, in molded plastic school colors and electrically retractable.
- Basketball court floor to have one large centrally located team mascot logo.
- 2 clear Plexiglas fixed backboards (rectangular 6' x 3 ½') with breakaway rims, protective padding, clear safety film and *National Federation of State High School Associations Court and Field Diagram* appliances for team possession timing (red lights at each competition backboard).
- 4 Fiberglass backboards (rectangular 6' x 3 ½'), electrically retractable.
- 10' runoff space at ends of basketball court .
- PA system hookups in the floor on the home team side at appropriate scorer's table location.

- 1 scoreboard (wireless) located on the end wall behind the main goal, not on the walls behind practice goals. Locate scoreboards so they can be viewed from scorer's table and team seating areas.
- Acoustical treatment of walls and ceiling so that students can hear the teacher's instructions. This is a teaching classroom and there should be no echoing of sound.
- Quality intercom system that can be clearly heard.
- Protected clock.
- Sound resistant walls/doors/ceilings.
- 1 Telecom with quad receptacle at each end of the gym.
- Gym walls should have hard and smooth surfaces for handball and paddle ball.
- Use translucent windows in gym to prevent glare. Windows should be at least 10' above the floor level.

Mechanical Criteria

- Good ventilation - air conditioning, fans, and heat system need to be quiet so that instructions can be heard.
- Provide separate air conditioning/heat control for gym.

Electrical Criteria

- Provide for electrical requirements of a scoreboard.
- Dual electrical outlets on each wall (per code), at least two dual outlets on each wall.
- Sound system with outlets for a microphone at several locations.
- Provide segregated security for gym.

Furniture, Fixtures and Equipment

- If less than 10' of runoff is provided at ends of the basketball court, provide protective wall mats under main baskets with school name and/or logo on mats.

RECEPTION / SECRETARY'S AREA

OBJECTIVES:

To provide a reception area that is warm, inviting and projects a professional image. The reception area should efficiently accommodate secretarial staff, students, visitors, and parents.

CAPACITY

8-10 people/visitors and 2 administrators, with 2 work stations behind counter.

ACTIVITIES:

- Monitoring of main entry camera and control of entry door locks.
- Greeting of parents and visitors.
- Control point of administrative suite.
- Registration of students entering or leaving during school hours.
- Broadcast of announcements.
- General secretarial activities and duties.

DESIGN CONSIDERATIONS

- Must have visual control over front entry of school and main corridor. Ideally have visual control over front parking areas.
- Proximity to principal and/or assistant principal.
- Adjacent to health room.
- Access to workroom and storage rooms.

PHYSICAL REQUIREMENTS:

Architectural Criteria

- Provide lobby/waiting area with functional seating arrangement.
- Provide desk height reception counter to divide waiting from secretarial spaces- Camera/front door locking security system to be integrated.
- Provide space for 2 work stations behind counter.
- Front door vestibule to provide security with locked doors to direct circulation through main office area.
- Visual access should be provided to front entrance to school and to the area outside the front entrance.
- Provide carpeted floors and/or VCT on the public side of the reception counter.
- Provide visual and audible access to Health room.
- Provide built-in coat closet.
- Provide 1" mini-blinds for all windows typical.

Mechanical Criteria

Electrical Criteria

- Provide six data outlets, each paired with a duplex electrical outlet, located on opposite walls and in reception counter to facilitate alternate furniture arrangements
- Provide duplex outlets elsewhere around the space at 6' on center
- Provide cabling in ceiling for wireless access point.
- Provide space for master intercom console and appropriate electric and communications connections.
- Provide space for master telephone and fax console.

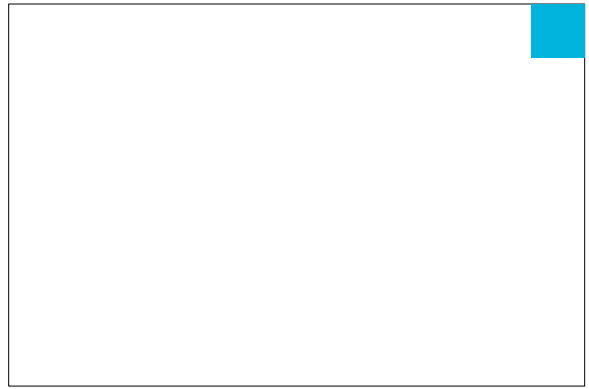

- Provide intercom/phone with volume control and privacy feature.
- Provide monitor mounted above head height facing secretarial staff. Provide cable TV connections and proximity to electricity with structural wall blocking for mounting monitor.
- Fire alarm and Intercom head end located in this area

Furniture, Fixtures and Equipment

- Provide reception counter with a combination of lockable storage units and open space to house three-drawer file cabinets below.
- Provide built-in display case.
- Provide two 4'x6' tackboards.

PRINCIPAL'S OFFICE

OBJECTIVES

The school administrative offices should provide a space wherein school-related business and concerns can be addressed with dignity in an attractive and suitable environment.

CAPACITY

2-6 people/guests - executive desk suite of furniture and conference table and chairs with credenza and bookshelves typical

DESIGN CONSIDERATIONS

- Office should be near but not adjacent to the main reception area
- Office should be in close proximity to administration team, student records and guidance area
- Office should be adjacent to dedicated conference room
- Administration suite should be designed so that the Principal's office can be located on either end of the suite of offices. Two options for locations, adjacent to a conference room is preferable
- Conference room to be equipped with marker board, tack board and bookshelves, typical

PHYSICAL REQUIREMENTS

- Provide carpeted floor
- Provide two computer outlets, each paired with a quad electrical outlet, located on opposite walls to facilitate alternate furniture arrangements
- Provide duplex outlets elsewhere around the space at approximately 6' on center
- Provide Intercom/phone with volume control and privacy switch
- Provide 1" mini-blinds for windows typical

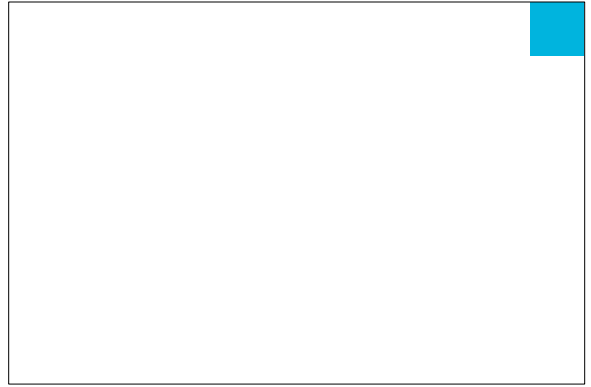

ASSISTANT PRINCIPAL'S OFFICE

OBJECTIVES

The Assistant Principal's office should provide a setting where daily school business, as assigned, can be transacted.

CAPACITY

2-4 people/guests. Assist. Principal executive desk suite of furniture

DESIGN CONSIDERATIONS

Close to principal's office, main reception/entrance and conference room

PHYSICAL REQUIREMENTS

- Provide carpeted floor
- Provide receiving area separate from the main office reception area
- Provide access to secondary exit from administration area
- Provide two computer outlets, each paired with a duplex electrical outlet, located on opposite walls to facilitate alternate furniture arrangements
- Provide duplex outlets elsewhere around the space at 6' on center
- Provide phone/Intercom with volume control and privacy switch
- Provide 1" mini-blinds for windows

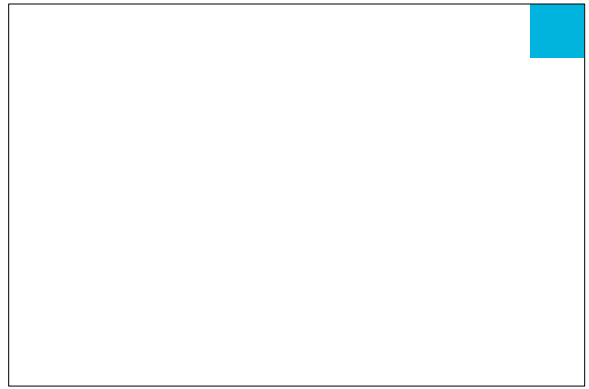

FINANCIAL SECRETARY OFFICE

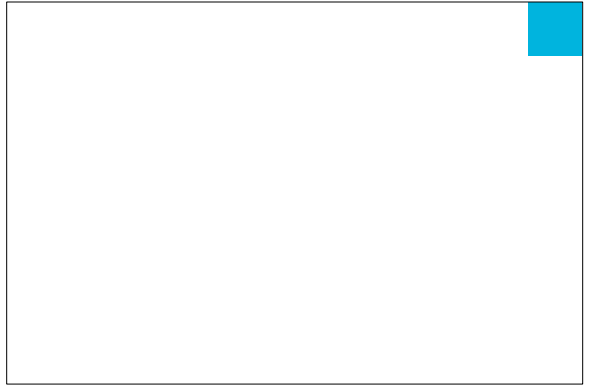

OBJECTIVES

Financial Secretary/Bookkeeping office should provide a quiet and private setting where school business transactions can be accommodated.

CAPACITY

2-4 people

DESIGN CONSIDERATIONS

Locate in administration office complex but away from high traffic areas.

PHYSICAL REQUIREMENTS

- Provide carpeted floor
- Provide two data outlets paired with quad electrical outlets
- Provide duplex outlets elsewhere around the space at 6' on center
- Provide intercom/phone with volume control and privacy switch

ITINERANT STAFF WORK SPACE

OBJECTIVES

To provide a "home base" for itinerant staff and allow for interaction and planning between professionals

CAPACITY

Four to six persons

ACTIVITIES

- Teacher and Staff Planning
- Office /Conference Space
- Storage of itinerant materials

DESIGN CONSIDERATIONS

- Locate itinerant staff in close proximity to main entrance, administration area and guidance area
- Locate to allow immediate access to a conference room
- Locate in close proximity to adult restrooms

PHYSICAL REQUIREMENTS

- Provide carpeted floor
- Provide intercom/phone with volume control and privacy switch
- Provide six computer outlets, each paired with a quad electrical outlet, minimum of one on each wall
- Provide duplex receptacles elsewhere around the perimeter of the space at 6' on center
- Provide 4'X 8' tack board. Top of tack board to be at 6'-8" AFF.
- Provide 1" mini-blinds for windows
- Workstations to be "touch-down" size, i.e. 6' x 6'

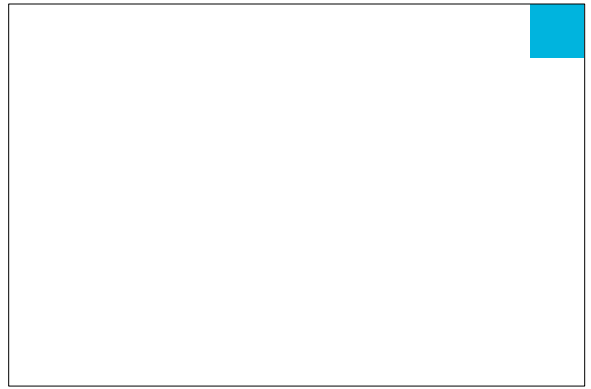

CONFERENCE ROOM

OBJECTIVES

The Conference Room should be shared by all administration personnel and should provide a quiet inviting setting for conferences and group assemblies for student or school business.

CAPACITY

10-12 people

ACTIVITIES

- Parent conferences
- Testing evaluations

DESIGN CONSIDERATIONS

Adjacent to Principal's office, Assistant Principal Offices and reception area – If possible twin locations of office/conference suites are to be provided to offer maximum flexibility to staff. This can be provided by designing two ends of a main administration wing with an office-conference room pairing.

PHYSICAL REQUIREMENTS

- Provide one data outlet paired with a duplex electrical outlet
- Provide duplex outlets elsewhere around the space a 6' on center
- Provide television connection, and mounts for monitor
- Provide 4'x8' marker board and 4 x8' tack board. Top of board to be at 6'-8" AFF.
- Provide intercom with volume control and privacy switch
- Provide carpeted floor

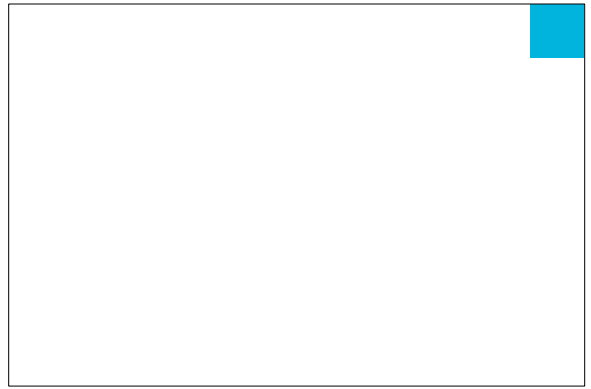

WORKROOM

OBJECTIVES

To provide workspace for teachers, secretaries, principal and assistant principals.

CAPACITY

2-4 people

ACTIVITIES:

- Storage (school supplies and system forms).
- Copying of materials.
- Laminating, assembling and distribution of staff mail
- General clerical tasks.

DESIGN CONSIDERATIONS

Locate in principal's office suite close to secretarial area and on a major corridor.

PHYSICAL REQUIREMENTS

Architectural Criteria

- Provide vinyl tile floor.
- Provide one wall of built-in base and overhead cabinets. All cabinets to be lockable. Units to be a mix of closed, open shelves, and drawers.
- Provide 12" deep shelving on all available walls of storage room.
- Provide work table per the details included in the A/E Guide Appendix.
- Provide teacher mail slots per the details included in the A/E Guide Appendix.

Mechanical Criteria

Electrical Criteria

- Provide intercom/phone with volume control and privacy feature.
- Provide two computer outlets in the workroom and one in the storage room, each adjacent to a quadruplex electrical outlet.
- Provide electrical outlets elsewhere at 6' on center.

Furniture, Fixtures and Equipment



FACULTY BREAKROOM

OBJECTIVES

To provide space for teachers and staff to take breaks and eat lunch.

CAPACITY

6-8 people

ACTIVITIES:

- Take breaks.
- Prepare coffee.
- Store and eat lunches.
- Access vending machines.

DESIGN CONSIDERATIONS

Locate in proximity to classroom wing. Provide space for (4) vending machines, a refrigerator, and base and wall cabinets where a microwave could be placed.

PHYSICAL REQUIREMENTS

Architcural Criteria

- Provide vinyl tile floor.
- Provide one wall of built-in base, sink and overhead cabinets. Units to be a mix of closed, open shelves, and drawers.

Mechanical Criteria

- Provide sink with hot and cold water.

Electrical Criteria

- Provide intercom/phone with volume control and privacy feature.
- Provide electrical outlets at 6' on center.

Furniture, Fixtures and Equipment

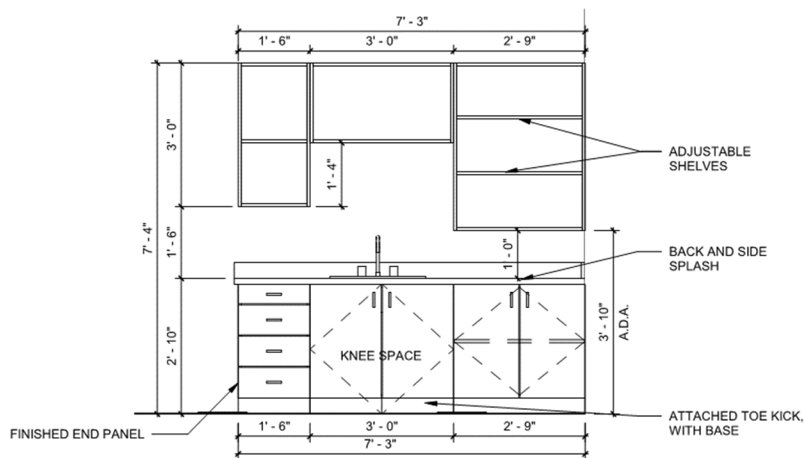

CASEWORK ELEVATION - FACULTY BREAK

$1/4" = 1'-0"$

STUDENT RECORDS

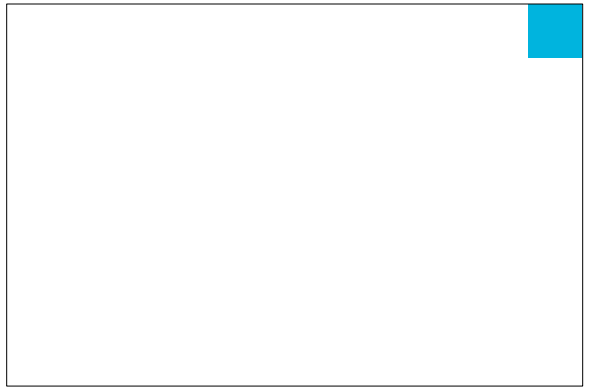

OBJECTIVES

To provide secure fire resistant area for storage of student records and school financial records.

CAPACITY

1-2 people

ACTIVITIES

- Storage of student files
- Retrieval of information
- Logging of information onto computer system

DESIGN CONSIDERATIONS

Locate adjacent to Student Services Office (for Registrar access) and adjacent to Financial Secretary Office. Locate in proximity to Principal and Assistant Principals.

PHYSICAL REQUIREMENTS

- Provide intercom/phone with volume control and privacy switch
- Provide one data outlet paired with a duplex electrical outlet
- Provide duplex outlets elsewhere around the space at 6' on center
- Provide minimum of 1-hr. enclosure
- Provide carpeted floor
- HVAC should be provided for occupiable office

HEALTH ROOM

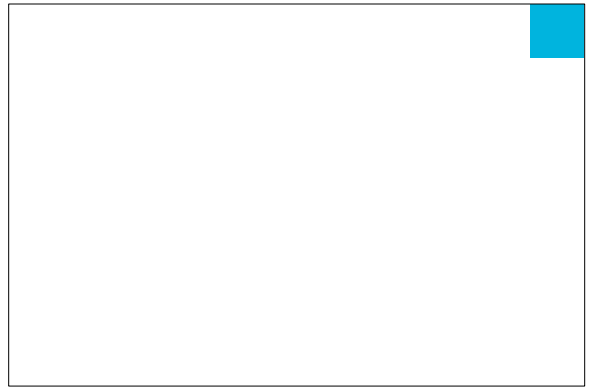

OBJECTIVES

To provide adequate space for school nurse to assess needs of students and staff in a private, confidential area; to triage sick and/or injured students, administer first aid and monitor status while waiting for parent pick-up; conduct required screenings and evaluations; to provide health counseling, case management and communicate with health care providers; and, serve as a center for health and wellness resources, education and activities for staff and students.

CAPACITY

4-6 people

ACTIVITIES

- Student examinations and/or treatment by the school nurse
- Resting area for sick and injured students or waiting for parent pick-up
- Administration of medication(s) and treatments
- Storage (first aid supplies, medication, linens for beds, wheelchair, scale, health information resources)
- Conduct required screenings and evaluations
- Nurse/student confidential conferences
- Confidential conversations with parent, staff and/or healthcare providers
- Collaboration with staff on health and wellness activities

PHYSICAL REQUIREMENTS

- Located near the main office, but away from the public, entrance behind the secretary/receptionist for supervision on days nurse is not present or occupied outside the health room
- Provide window for observing students from secretary area, but placed for privacy/confidentiality so visitors entering the reception area cannot see students in the health office
- Ideally two entrances; one to office area and one to hallway
- Provide 1" mini-blinds for windows for privacy
- Provide vinyl composition tile floor or rolled rubber heat welded (no carpet)
- Provide private accessible restroom with hot (tempered)/cold water and accessible shower (if a shower is not otherwise provided within the school at a modified rest room) with floor drain typical.
- Provide sink with hot (tempered) and cold water and counter with lockable drawers and storage
- Provide paper towel and liquid soap dispensers at the sink
- Restroom should be sized to allow for a changing area and the use of a small cot
- Provide intercom/phone with volume control and privacy switch
- Provide two computer outlets, each paired with quadruplex electrical outlet, located on opposite walls to facilitate alternate furniture arrangements
- Provide duplex outlets elsewhere as needed
- Provide wall clock
- Provide privacy curtain from the ceiling to visually separate cots
- Provide ADA-compliant mini refrigerator with lock (include in GC contract), positioned within base cabinet.

EQUIPMENT

- Provide 2 cots in storage near restroom
- Provide four drawer lockable file cabinet for confidential files

- Provide two computer drops, each paired with quadruplex outlets located on opposite walls to facilitate furniture arrangements and away from door to provide privacy
- Nurses desk to be lockable with adult desk chair
- Provide 4-6 student sized chairs
- Provide sufficient storage for surplus clothing on shelves with covered containers
- Provide bookcase
- Provide biohazard waste garbage container
- Provide “Sharps” container
- Provide 4’x8’ tack board. Top of board to be at 6’-8” AFF.
-

STUDENT SERVICES OFFICE & CONF. RM.

OBJECTIVES

The Guidance and Student Services program is designed to assist students and their families with students' normal progression through the developmental stages in the areas of learning, social skills, and career planning. Each elementary school has a full-time Student Services Specialist (certified in school psychology with training school counseling and school social work). To deliver a comprehensive Student Services program, the Student Services Specialist:

Provides classroom guidance concerning personal and social skills, career development and study skills
Consults with school staff and parents
Conducts psychological evaluations of students who have learning or behavioral problems
Provides individual and group counseling
Serves as liaison between home, school and community resources

CAPACITY

Office 3-5 people with corner area for “kid-friendly” interviews

Conference 6-10 people

DESIGN CONSIDERATIONS

The Student Services office should be located near the mainstream of student traffic, with direct student entrance without going through the administrative offices. Access to the administrative office for records is desirable. Separation from high noise areas is needed.

PHYSICAL REQUIREMENTS

Office:

- Provide two data outlets, each paired with quad electrical outlet, located on opposite walls to facilitate alternate furniture arrangements
- Provide duplex outlets elsewhere around the space at 6' on center
- Provide intercom/phone with volume control and privacy feature.
- Provide carpeted floors
- Kid-friendly interview space

Conference

- Provide intercom/phone with volume control and privacy feature
- Provide data connection
- Provide television connection for wall mounted monitor

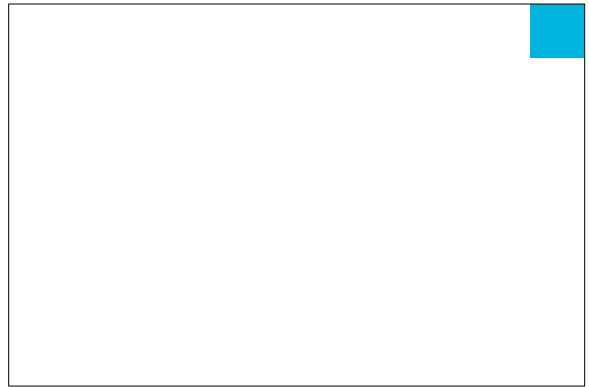

PARENT CENTER

OBJECTIVES

The Parent Center is a place for interaction between parents, teachers and administrators. It is also the location for parent resources and educational information.

CAPACITY

6-8 people

DESIGN CONSIDERATIONS

Parent center should be located close to administration area, main entrance, and staff accessible restrooms. Must be wheelchair accessible.

PHYSICAL REQUIREMENTS

Architectural Criteria

- Provide carpet.
- Provide three 48"x84" high book shelf units.
- Provide 6' long counter with sink and under counter storage consisting of drawer and closed lockable units.
- Provide one 4'x8' tackboard. Top of board to be at 6'-8" AFF.

Mechanical Criteria

Electrical Criteria

- Provide three data outlets, each grouped with a quadruplex receptacle. Provide wireless access point.
- Provide duplex outlets elsewhere around the space at 6' on center.
- Provide intercom/phone with volume control and privacy feature.

Furniture, Fixtures and Equipment

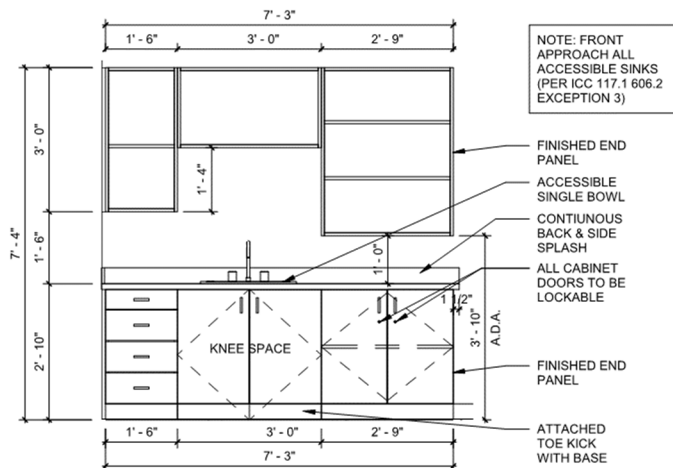

CASEWORK ELEVATION - PARENT CNTR

1/4" = 1'-0"

WELLNESS ROOM

OBJECTIVES

Employee wellness rooms can help ease stress and tension around the workplace. Per Section 4207 of the Patient Protection and Affordable Care Act, new mothers also need a private, designated space to nurse. This space is intended for staff use only.

CAPACITY

1-2 people

ACTIVITIES:

- Accommodate nursing mothers.
- Provide a private area for administering medication, stress relief, or work breaks.
- Provide an area for employees with migraines to receive sensory relief.

DESIGN CONSIDERATIONS

- The Wellness Room is to accommodate casework for storage, sink and small refrigerator, as a private room for individual use.

PHYSICAL REQUIREMENTS

Architectural Criteria

- Provide a design scheme with subtle colors, pale hues like light gray and beige, to make it easier for employees to relax and unwind.
- Provide carpeted floor.
- Provide high-NRC acoustical ceilings.
- Provide entry lock door hardware with occupied/vacant indicator.
- Provide casework with sink and under-counter refrigerator.
- Provide ADA-compliant mini refrigerator with lock (include in GC contract), positioned within base cabinet.

Mechanical Criteria

- Provide a small sink at the casework with hot (tempered) and cold water.
- Provide heating/cooling with individual sensors to control space temperature.

Electrical Criteria

- Provide LED lighting with the ability to dim lights.
- Provide intercom/phone with volume control and privacy feature.
- Provide power for refrigerator.

Furniture, Fixtures and Equipment

- Provide comfortable furniture for employees to rest in, with enough flat surfaces to place their belongings.

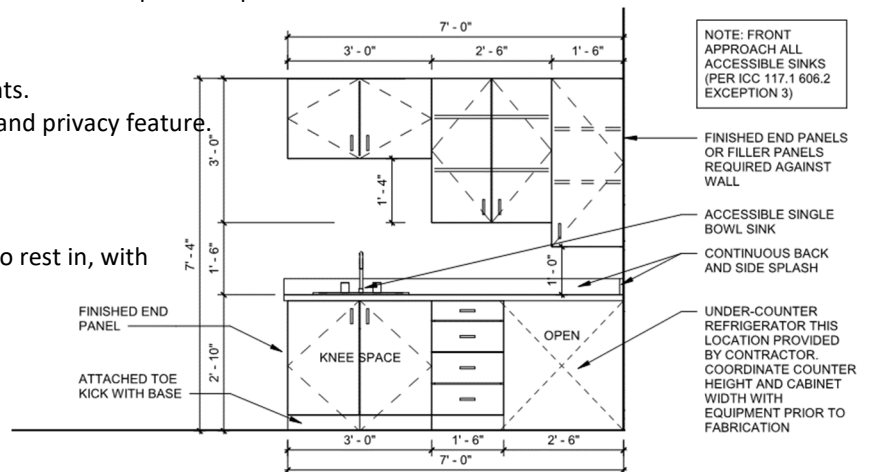

CASEWORK - WELLNESS

$1/4'' = 1'-0''$

SRO OFFICE

OBJECTIVES

To provide a space for a police officer assigned to the school.

CAPACITY

1 resource officer

DESIGN CONSIDERATIONS

Should be located in the administration area of the school, preferably close to the main or secondary entrance to the administrative area.

PHYSICAL REQUIREMENTS

Architectural Criteria

- Provide vinyl tile if accessed from Corridor. Provide carpet if accessed from Admin.
- Provide one 4'x6' tackboard. Top of board to be at 6'-8" AFF.

Mechanical Criteria

Electrical Criteria

- Provide two computer outlets, each adjacent to a quadruplex electrical outlet.
- Provide duplex electrical outlets elsewhere at 6' on center.
- Provide intercom/phone with volume control and privacy feature.

Furniture, Fixtures and Equipment

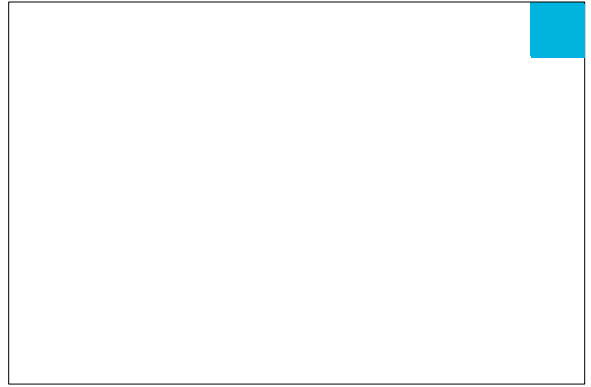

CAFETERIA AND KITCHEN

OBJECTIVES

Nutrition programs play a vital role in the education of students. As a “partner in education” it is the role of child nutrition programs to make mealtime a pleasant experience by providing adequate dining and food preparation facilities which will encourage students to consume the nutritious meals needed for growth, development, and learning readiness. The dining area is sized for three seatings of the design student population.



CAPACITY

Student Population/Three Seatings

ACTIVITIES

Receiving food and associate kitchen materials and equipment in order to prepare food for student’s meals to include breakfast, lunch and occasional snacks and community events.

DESIGN CONSIDERATIONS

- Dining area: Located adjacent to the multi-purpose room with a movable partition to divide these two spaces acoustically insulated to minimize noise from the adjacent area.
- Serving area: Adjacent to kitchen and dining with easy access for supply or fresh food; accessible with appropriate counter heights.
- Food preparation: The food preparation and storage areas shall be accessible from a loading area to allow for deliveries of supplies and the removal of food debris.
- Dish wash area: Adjacent to dining room with traffic pattern not to interfere with serving lines.
- Manager’s office: Locate at rear of kitchen with full view of back door, storage entrances, and preparation areas. Window to outside with security screen.
- Employee restroom: Located adjacent to food preparation area opens to locker room.
- Locker room opens to kitchen with 10-12 double height lockers and associated closet for data
- Storage area: The food preparation and storage areas shall be accessible from a loading area to allow for deliveries of supplies and the removal of food debris. If storage is located directly next to a cooler or freezer, additional insulation is required to prevent possibility of mold.
- Separate security system for kitchen is recommended to allow early access by staff. Area to accommodate separate key pad zone
- Provide buzzer/doorbell at back entrance. Buzzer to “announce” in Kitchen near manager’s office
- Provide peephole on back door.
- Provide can wash facility with mop rack in delivery area and accessibility to dumpsters

PHYSICAL REQUIREMENTS

Dining Area:

- Provide 20 foot candles minimum. Dual switch to 40 foot candles of light is recommended for special occasions
- Provide additional wiring in walls for future satellite serving areas
- Provide 2 Ethernet ports and 2 electrical outlets over entrances to serving area for flat screen. See A&E Guide for current minimum requirements, typical.
- Provide ample electrical outlets
- Provide VCT Flooring
- Provide intercom
- Provide television connection – minimum of two at 18” AFF

- Provide minimum two computer network drops with adjacent quad power outlets
- Do not limit all dining to the inside of the building. Patios and outdoor gardens may be utilized for dining
- Plan windows that are at eye level and allow light to enter and provide a pleasant outside view
- Material selections for ceilings and walls should be as sound absorptive as possible to reduce noise. Flags and ceiling hangings can reduce noise levels
- Provide electric water cooler with bottle filler in Dining Area. Locate water cooler adjacent to Serving line.

Serving Area:

- 70 foot candles of light is recommended
- Electrical connections required for equipment
- Floor drains as required for equipment
- Data outlet paired with quadruplex outlet at each cashier
- Provide VCT floor
- Smooth durable washable wall surfaces

Food Preparation:

- 70 foot candles of light is recommended. Provide natural light whenever possible
- Provide quarry tile or epoxy floor
- Provide electrical wiring as required for all equipment.
- Floor drains or floor sinks to be provided as required for equipment
- Provide vertical closure panels over the top of all walk-in freezers and coolers. Locate floor drains for these coolers and freezers out of traffic path.
- Provide hand wash sinks, where required server, kiosk and kitchen locations. Provide soap and tri-fold paper towel dispensers at all hand wash sink locations.
- Kitchen hood area: The exhaust hood shall be stainless steel with adequate lighting. The water source under the hood shall have a vacuum breaker. The fire suppression system push-button activator shall be located near the entry/exit door. Include stainless steel utility chase and fire suppression system.
- The utilities for the equipment shall be arranged in such a way to facilitate easy cleaning behind the equipment.
- Drains are needed throughout, especially under the braising pan, icemaker, etc.
- The location of drains should be out of circulation paths and appropriate for use when the equipment is tilted and the water is draining, and so that steam from the drain does not interfere with operation (pilot lights, etc.) of other equipment.
- CO sensor with digital readout required in kitchen.
- Provide stand-alone HVAC system

Dish Wash Area:

- 70 foot candles are recommended
- Provide direct wiring of dish machine
- Provide hood with fan to draw steam out of area
- Provide water temperature 140 degrees to kitchen 180 degrees by booster heater on demand
- Provide garbage disposal
- Provide smooth durable washable wall surfaces
- Hose bibb shall be located in the dish room.
- Provide wall mounted fans in the dishwashing room and as directed by CMS.

Storage Area:

- 70 foot candles are recommended
- Dry storage area to be ventilated with fresh air venting system
- A notice board for menu, message, and other types of communication is essential
- Must have flexible shelving. When planning new storage rooms think in terms of rows of shelving with adequate aisles between.
- Provide 4' x 6' bulletin board for employee communication.
- Rows of shelving with adequate aisles between are desired.
- Provide quarry tile floor
- Provide smooth durable washable wall surfaces

Manager's Office:

- 70 foot candles are recommended
- Provide ample electric outlets
- Provide 3'x 4' bulletin board.
- Provide smooth durable washable walls
- Provide 2 Data outlets paired with quadruplex outlets
- Provide intercom/phone with volume control and privacy feature.
- Provide telephone connection with kitchen speaker-bell

Internal cold storage freezer and cooler

Provide all kitchen food preparation equipment as specified by A&E Guidelines.

Provide 1" mini-blinds for windows, typical

Provide recycling area with bins in kitchen, delivery area, and cafeteria dining area

PLANT OPERATIONS

OBJECTIVES

To provide space for the activities involved with Plant Operations and Maintenance on a day to day basis.

DESIGN CONSIDERATIONS

- Janitor/storage rooms should be located near opposite ends of the floor plan to provide convenient distances to all classrooms and storage areas as well as trash pick-up and recycling areas.
- Laundry should be located near one of the janitor rooms
- Loading area should be located adjacent to the kitchen-cafeteria area
- Storage room located near loading dock for central receiving and staging

PHYSICAL REQUIREMENTS

- Each janitor/storage room should contain a mop sink, mop rack, and shelving
- Outdoor storage will be provided by owner, post occupancy and should be added to the site plan for location of circulation and security. Outdoor storage should be oriented towards the play fields. Provide concrete pad and appropriate driveway and sidewalk access and/or ramp to future storage container



CUSTODIAL ROOMS

OBJECTIVES

To provide space for the storage of supplies and equipment used on a day to day basis

DESIGN CONSIDERATIONS

- Custodial/storage rooms should be located near opposite ends of the floor plan to provide convenient distances to all classrooms and storage areas as well as trash pick-up and recycling areas.
- Laundry should be located near one of the custodial rooms
- Loading area should be located adjacent to the kitchen-cafeteria area
- Storage room located near loading dock for central receiving and staging



PHYSICAL REQUIREMENTS

- Each custodial/storage room should contain a mop sink, mop rack, and shelving
- Outdoor storage will be provided by owner, post occupancy and should be added to the site plan for location of circulation and security. Outdoor storage should be oriented towards the play fields. Provide concrete pad and appropriate driveway and sidewalk access and/or ramp to future storage container
- Provide at least one main custodial room in a central location, large enough to accommodate floor buffing machines and include (1) data and quad power receptacles, intercom (handset and speaker), telephone outlet and coat hook on back of door.
- Remote custodial rooms shall include a 24" x 24" mop sink with stainless steel backsplash, mop rack, and 24" deep metal shelving.
- One custodial room to have washer/dryer; vent dryer to exterior.
- Spaces to receive sealed concrete floor finish and CMU walls.
- Ceiling to be acoustical tile or open to structure.
- Hot and cold water, ventilation per code.
- Rooms to be lockable.
- Provide additional shelving in each Custodial Room for storage of attic stock materials, per the A/E Guide.

STAFF TOILETS

OBJECTIVES

To provide space for toilets facilities for staff.

DESIGN CONSIDERATIONS

- Staff toilet rooms should be located evenly throughout the building.

PHYSICAL REQUIREMENTS

- Provide ADA compliant mirror over ADA sink.
- Provide a full height mirror on the wall.
- Porcelain tile floor and base.
- Epoxy paint on the wall.
- The preference is for the door to swing out.
- Provide a GFCI outlet.
- Ceiling to be gypsum or scrubbable ceiling panels.

